



RACING

Mustang Dark Horse R Homologation



Table of Contents

General Notes.....	3	2024 Seat Mount Configuration.....	62
Front Fascia Assembly.....	4	2025 Seat Mount Configuration.....	63
Front Fascia Assembly – Parts in Assembly	5	2026 Seat Mount.....	64
Front Fascia – Splitter.....	6	Safety Equipment – Fire Suppression.....	65
Front End.....	7	Safety Equipment.....	66
Rear Fascia Assembly.....	8	Window Nets.....	67-68
Exterior.....	9	Safety Harness and Helmet Support Net	
Rear View Mirrors.....	10	Collars.....	69
Driver Door / Floor.....	11	Roll Bar Padding.....	70
Dash Panel.....	12-13	Recommended Fluids.....	71
Ballast.....	14-16	Under Hood / Trunk.....	72
Hood Pins.....	17	Interiors.....	73
Defog Kit.....	18	Front Wheel Well.....	74
Trunk.....	19	Rear Wheel Well.....	75
Underbody.....	20	Body in White (BIW).....	76
Engine.....	21	Chassis Serial Number.....	77
Engine – Seal Locations.....	22	Appendix.....	78-104
Engine Cooling.....	23-26	Driver Safety Harness System Location.....	79
Exhaust.....	27	Master Power Electrical Switch.....	80
Exhaust – Heat Wrap.....	28	Fire Suppression System.....	81
Fuel Cell.....	29-30	Air Jack System – Optional.....	82-86
Fuel Lines.....	31	Radio.....	87
Subframes.....	32-33	Yellow Flag Warning System.....	88
Suspension.....	34-36	Safety System.....	89-90
Dampers.....	37	Transponder.....	91
Optional Springs.....	38	Transmitter – Mustang Cup AU.....	92
ABS.....	39	Incident Data Recorder.....	93
Brakes.....	40	Camera System.....	94-96
Brake Disc Assembly.....	41	Driver Cooling System.....	97
SS Brake Lines.....	42	Driver Cooling System Mount.....	98
Flexible Brake Lines.....	43	Ride Height / Splitter Height Reference	
Driveline.....	44-45	Points.....	99
Driveline – Half Shafts.....	46	Front / Rear Fascia Mount Repair.....	100
Driveline – Clutch.....	47	Engine Service Pigtails.....	101-103
Driveline – Cooling Lines.....	48	Change Log.....	104
Driveline – Catch Cans.....	49		
Transmission – Seal Locations.....	50		
Rear Axle – Seal Location.....	51		
Steering.....	52		
Wheel & Tires.....	53-54		
Data.....	55		
Electrical.....	56-58		
Driver’s Seat.....	59-61		

General Notes

- This homologation document is for Mustang Challenge and Mustang Cup
 - Mustang Challenge North America (NA) is sanctioned by IMSA (International Motor Sports Association)
 - Mustang Cup USA is sanctioned by USAC (United States Auto Club)
 - Mustang Cup Australia (AU) is sanctioned by Motorsport Australia
- Adjustments or modifications not specified in this document are not allowed
- The only optional equipment allowed is shown in this document
- All parts on vehicle must be production Ford Mustang Dark Horse components unless specifically listed in this document as detailed in the Bill of Materials
- Fluids are unrestricted. The recommended fluids are listed in this document
- Valve stem specification is open. Valve stem caps are required
- This homologation document may be updated if vehicle specification changes are made
- Updates will be available on the Ford Performance website
 - Mustang Challenge: [Competitor Info – Mustang Challenge](#)
 - Mustang Cup: [Competitor Info – Mustang Cup](#)

Front Fascia Assembly



Front Fascia Assembly
FP-17001-DHR



Front Fascia Assembly
FP-17001-DHR

Front Fascia – Parts in Assembly (PIA)



Front Upper Grill Assembly
FR-8200-DHR

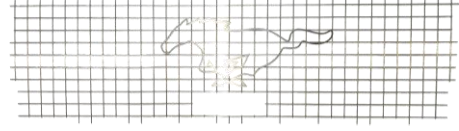

Front Upper Grill Mesh Insert
DHR-MESHGRL-UPRA



Front Lower Grill Assembly
FR-17K945-DHR

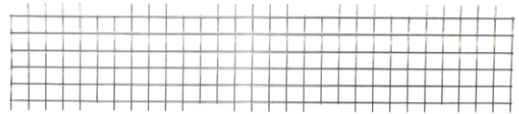

Front Lower Grill Mesh Insert
DHR-MESHGRL-LWR



Brake Duct Inlets
LCR-DH-BDK

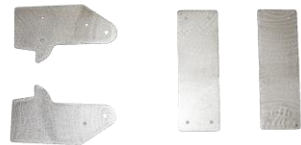

Brake Duct Mounting Bracket
DHR-BRK-DCT-MNT-BRKT

Front Fascia – Splitter



Splitter Support Assembly



Splitter, Modified
FR-17626-DHR



Splitter Support
LCR-DHR-SPLTR



Splitter Bumper Bracket
LCR-DHR-BMPR-BRKT



Splitter Pencil Rod
LCR-DH-PENCIL

Front End



Radiator Closeout
DHR-RADCLOSEOUT



Brake Duct Hose Kit
LCR-DH-BHKA / LCR-DH-BHK

Optional

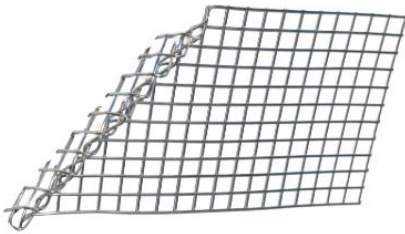

Brake Duct Screen LH
DHR-BRKDCTSCRNLH

Optional

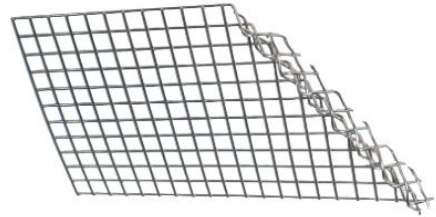

Brake Duct Screen RH
DHR-BRKDCTSCRNRH

Optional



Hood/Headlight Seal
FR-16990-DHR

Rear Fascia Assembly



Rear Fascia
FP-17500-DHR

Exterior



Cowl Top Assembly
FR-63022A68-DHR



Exterior Power Panel (Master Power / Fire Suppression
Pull Cable)
DHR-EXTRPWRPNL



Tow Hook Kit – Rear
FP-17954-RDH



Tow Hook Kit – Front
FP-17654-FDH



Wing Wicker
DHR-WING-EXTEN



Transponder Bracket
DHR-LAPSBKRT



Battery Tray
FR-10732-DHR

Rear View Mirrors



Rear View Mirror
JOES-11284



Rear View Mirror Brackets
JOES-11284

Optional



5" Rear View Mirror Brackets
JOES-11264

Optional



9" Rear View Mirror Brackets
JOES-11294

Optional



Side View Mirror
JOES-11214

Optional



Extended Side View Mirror Bracket
JOES-11234

Driver Door / Floor



Heat Shield
DHR-FLOOR-HT-SHLD

Optional

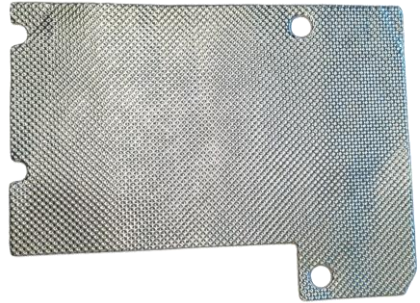

Heat Shield Insulator
LCR-DHFM



Dead Pedal Kit
WR-DEADPEDAL



Door Foam – LH
DHR-IMPAXX-LHFOAM



Door Latch Assembly – LH
DHR-DOORLTCHCABL



Inner Door Panel – LH
DHR-INNR-DOOR-PNL

Dash Panel



Main Dash Panel Assembly, Modified
FR-C04304-DHR



Main Dash Panel Top, Modified
FR-C04304-DHR

Dash Panel



Dash Panel Closeout
DHR-DASHCLOSEOUT

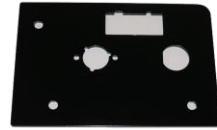

OBD2 Mounting Plate
DHR-OBD2-MNT-PLT

Ballast



Ballast Assembly Location – Passenger Side Floor
Ballast Assembly may be removed if not required

Required – Mustang Challenge NA
Optional – Mustang Cup USA & AU

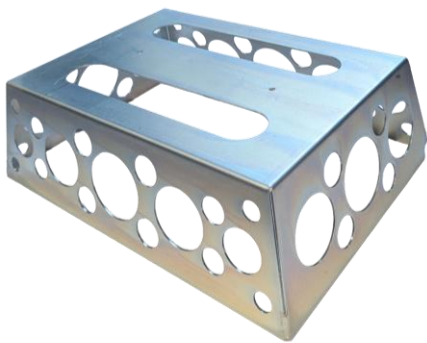

Ballast Box Cover
FR-6170-A



Ballast Mount w/ Hardware
200171-14-0000

Ballast



Ballast Assembly Location – Passenger Side Floor
Ballast Assembly may be removed if not required

Required – Mustang Cup USA & AU



Ballast Cover (Clear)
20017-03-0182AA01



Ballast Mount w/ Hardware
200171-14-0000

Ballast



Ballast Plate, 2.5 mm (1.9 lbs / 0.86 kg) (Not Included)
20017-03-0062

Ballast plates with the same 5-hole pattern as plates shown in this page are allowed

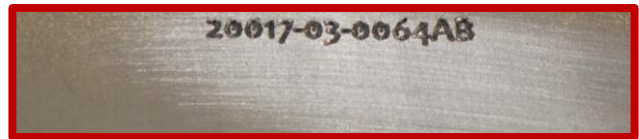

Ballast Plate, 5.0 mm (3.8 lbs / 1.72 kg) (Not Included)
20017-03-0064

Ballast plates with the same 5-hole pattern as plates shown in this page are allowed

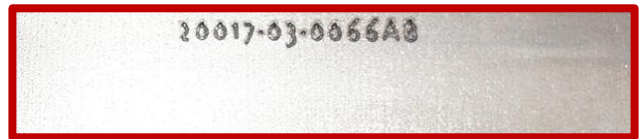

Ballast Plate, 10.0 mm (7.6 lbs / 3.45 kg) (Not Included)
20017-03-0066

Ballast plates with the same 5-hole pattern as plates shown in this page are allowed

Hood Pins



Hood Pins
120-4000

Required – Mustang Challenge NA & Mustang Cup USA



Hood Pin Reinforcement Kit
FR-16700-KIT

Defog Kit

Optional



Defog Kit
LCR-DHR-DDK

Trunk



Rear Closeout
DHR-REARCLOSEOUT-AS



Trunk Latch Assembly
FR-7643282-DHR



Trunk Release Handle Location
– Must be clearly labeled –

Underbody



Rear Diffuser
FR-6P013-DHR



Tie Down Kit – Front / Rear
M-1700-M

Engine



Sealed Engine – View 1
FP-6007-DHR



Sealed Engine – View 2
FP-6007-DHR



Sealed Engine – View 3
FP-6007-DHR



Sealed Engine – View 4
FP-6007-DHR

Engine – Seal Location



Engine Seal 1
Timing Cover Seal

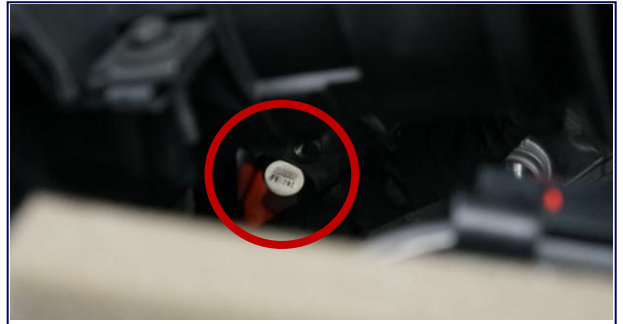

Engine Seal 1
Timing Cover Seal



Engine Seal 2
Valve Cover LH Seal



Engine Seal 2
Valve Cover LH Seal



Engine Seal 3
Valve Cover RH Seal



Engine Seal 3
Valve Cover RH Seal



Engine Seal 4
Intake Manifold Seal



Engine Seal 4
Intake Manifold Seal

Engine Cooling



Oil Cooler
SET50-960-7612



Oil Cooler Adapter
M22AN12-SE



Catch Can
PTR08-0400-FPR



Oil Cooler Fitting Adapter Kit
LCR-OCA-12



Catch Can Bracket
PVC-TRNS-VNT-BRKT



Catch Can to Oil Pan Drain Back Hose
CATCH-CAN-DRAINBACK-HOSE

Engine Cooling



Radiator (Optional for Chassis 001-040)
CR-CC-Y1196-002



Radiator
CR-CC-Y1100-002



Lower Radiator Aluminum Hose
FP-8286-A



Zip Tie Stud Mount
157-00291



Lower Radiator Soft Hose, 5.5 in
Inlet to Thermostat Housing
FP-8286-B



Lower Radiator Soft Hose, 4.5 in
Radiator Side
FP-8286-C

Engine Cooling



Heater Bypass Hose
(Optional for Chassis 001-040)
WR-18K580-MODA



Heater Hose
WR-18K580-MOD



Oil Cooler Line 1, Engine Out / Cooler In
S650-DHR-OIL-LINE1A / S650-DHR-OIL-LINE1



Oil Cooler Line 2, Cooler Out / Engine In
S650-DHR-OIL-LINE2A / S650-DHR-OIL-LINE2

Engine Cooling



Fan Motor / Shroud, Modified
FR-8C607-DHR

Exhaust



Headers LH/RH
FP-9430-DHRL / FP-9430-DHRR



X-Pipe
FP-5200-DHRX



LH Collector Pipe
FP-5200-DHRLC



RH Collector Pipe
FP-5200-DHRRC



LH Tail Pipe
FP-5200-DHRLT



RH Tail Pipe
FP-5200-DHRRT

Exhaust – Heat Wrap

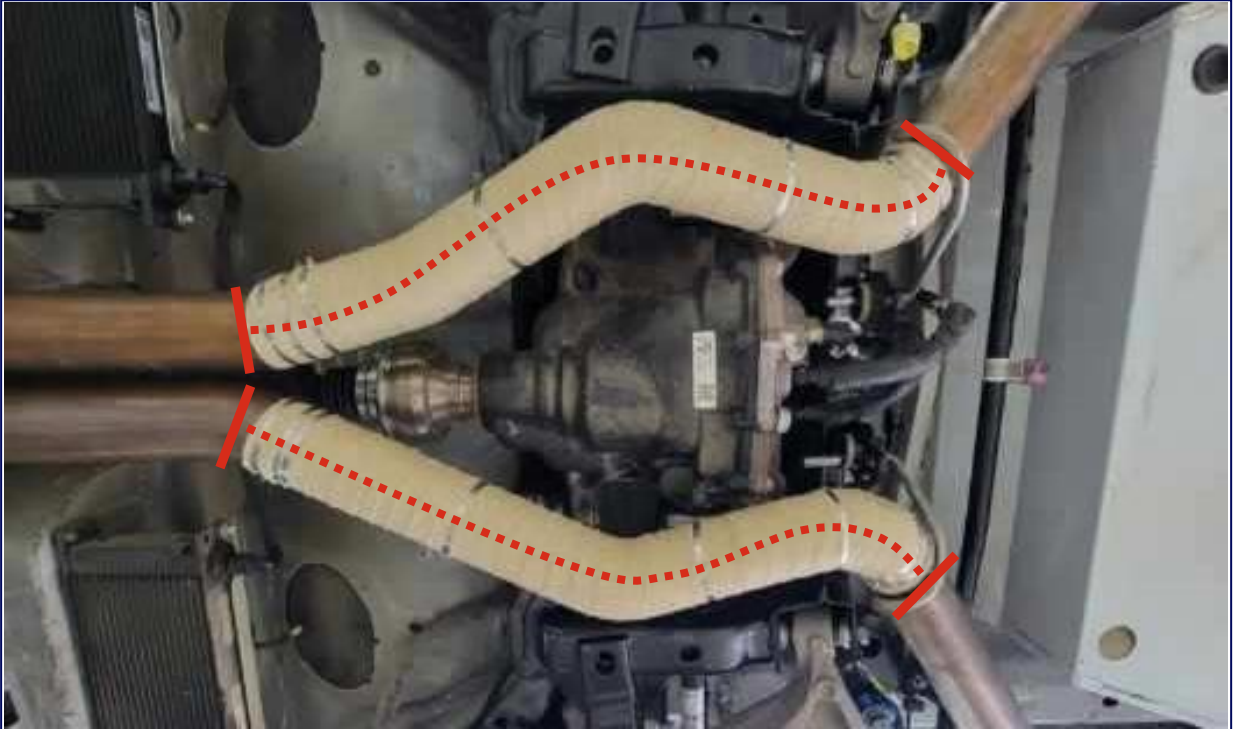

Exhaust Heat Wrap Location (Red Dotted Line)
Use a 50% overlap of the heat wrap. Use band clamps on both ends, additional clamps may be used.



COOL IT Thermo Tec Exhaust Insulating Wrap, 2"
THT-11002

Fuel Cell



Fuel Cell Spacer
DHR-FUEL-SPACERA



Fuel Cell Lid
DHR-FUEL-SPACERA



Fuel Line Fitting
GEN-GA3186

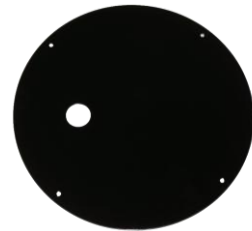
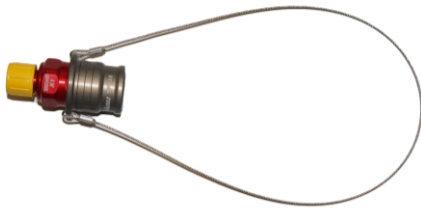

Plate (Fuel Pump Block Off)
DHR-FUELPMPBLKOFF



Ball Locking Break Socket (Red)
STA-SPT08.3655/L/JKV



Ball Locking Break Plug (Red)
STA-SPT08.7655/L/JKV



Fuel Cell Bladder Assembly
LCR-DH-FUELCELL

Fuel Cell

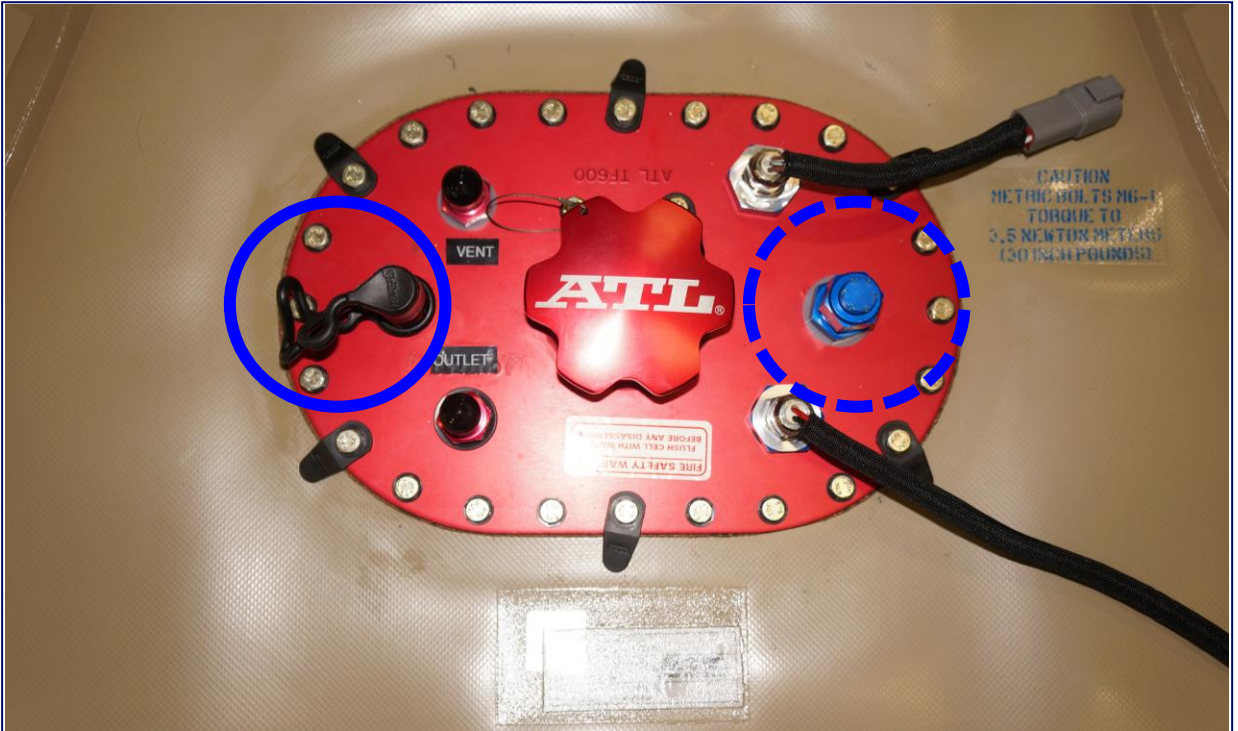

Fuel Cell Fitting Location
Quick Disconnect (Circled with Solid Blue Line) / -8 AN Bulkhead (Circled with Dotted Blue Line)

Required



Quick Disconnect & Nut
SPT08.5655/L/JKV

Optional



-8 AN Bulkhead Fitting & Nut / Cap
AN929-8D / TF232

Fuel Lines

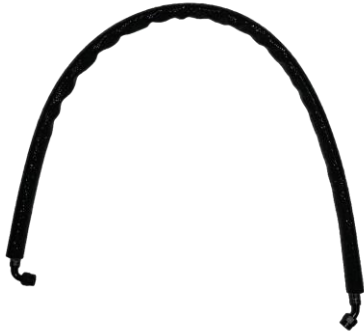

Fuel Line – Factory to Bulkhead
S650-DHR-FUEL-LINE1



Fuel Line – Bulkhead to Quick Release
S650-DHR-FUEL-LINE2



Fuel Line – Quick Release to Cell
S650-DHR-FUEL-LINE3



Fuel Vent Hose
DHR-FUELVENTHOSE

Front Subframe



Front Subframe (K Member)
FR-5C145-DHR

Rear Subframe



Rear Subframe
DHR-SUBFRAME-MODA



Bearing Kit for Control Arms - Front / Rear
SBK-60-1000



Bearing Kit for Control Arms - Front / Rear
SBK-60-1000

Suspension



Front Lower Arm Assembly – LH
DHR-FCNTRLBRNG-MODL



Front Lower Arm Assembly – RH
DHR-FCNTRLBRNG-MODR



Front Brake Line Bracket
DHR-LH-FRT-BRKLNBKRT /
DHR-RH-FRT-BRKLNBKRT



Adjustable Link (Front Anti Roll Bar)
DHR-FRTSWYBRLINK-AS



Front Wheel Stud / Nut
10-0119 / 40-0001-B



Rear Wheel Stud / Nut
10-0042 / 40-0001-B

Suspension



Knuckle / Bearing Assembly LH
CM-5B759-S650



Knuckle / Bearing Assembly RH
CM-5B758-S650



Upper Shock Mount – RH / LH
DHR-RUPRSHKMOUNT



Lower Shock Mount, Top
LCR-LSBRKT-DH



Lower Shock Mount, Bottom
DHR-RLOWERSHKMNT



Rear Toe Link Assembly
DHR-TOE-LINK-ASSY-R2



Adjustable Rear Drop Link w/ Hardware
LCR-DH-RSBL
Anti Roll Bar and Adjustable Drop Link must be connected



Front Knuckle Backing Plate
DHR-FT-BEAR-CV

Suspension



Rear Lower Control Arm LH
DHR-RCNTRLBRNG-MODL



Rear Lower Control Arm RH
DHR-RCNTRLBRNG-MODR



Rear Upper Camber Arm – LH
200171-12-1017



Rear Upper Camber Arm – RH
200171-12-1016



Rear Camber Shim, 0.5mm (.13 Deg)
200171-12-1004 AB



Arm Camber Shim, 1.0mm (.26 Deg)
200171-12-1006 AB



Rear Camber Shim, 1.5mm (.39 Deg)
200171-12-1008 AB

Dampers



Spring, Rear (As Delivered)
18C1000



Spring, Front (As Delivered)
187B0700



Spring Bearing Kit, Rear (2")
GEN-GC1017



Spring Bearing Kit, Front (2.5")
GEN-GC1015



Front Damper Assembly – LH/RH
FP-18000F-DHR



Front Camber Adjuster Plates – LH/RH
FR-18183L-DHR / FR-18183R-DHR



Rear Damper Assembly – LH/RH
FP-18000R-DHR



Front Camber Shims
PIA to Front Camber Adjuster Plates

Optional Front / Rear Springs

Front Hyperco Springs

SKU	Inside Diameter [in]	Free Length [in]	Rate [lbs/in]	Deflection [in]	Load [lb]	Outside Diameter [in]	Solid Height [in]	Color
187B0500	2.5	7	500	4.403	2202	3.661	2.597	Blue
187B0600	2.5	7	600	4.260	2556	3.708	2.740	Blue
187B0700	2.5	7	700	4.103	2872	3.687	2.897	Blue
187B0800	2.5	7	800	3.991	3192	3.729	3.009	Blue
187B0900	2.5	7	900	3.793	3413	3.834	3.207	Blue



Rear Hyperco Springs

SKU	Inside Diameter [in]	Free Length [in]	Rate [lbs/in]	Deflection [in]	Load [lb]	Outside Diameter [in]	Solid Height [in]	Color
186C0700	2	6	700	3.317	2322	3.009	2.683	Blue
186C0800	2	6	800	3.293	2634	3.203	2.707	Blue
186C0900	2	6	900	3.146	2831	3.156	2.854	Blue
186C1000	2	6	1000	3.070	3069	3.128	2.930	Blue



ABS



Dark Horse R ABS M5 Clubsport Kit
FP-2353-DHR



MSA Box, Signal Converter
F02U.V00.327-03



ABS Sensor - Front LH
JR3C-2C204-B1B



ABS Sensor - Front RH
JR3C-2C205-B1B



Front ABS Wire Hanger LH / RH
DHR-FRT-ABSWRBRKT



ABS Wire Bracket LH / RH
FR-2C224A-DHR / FR-2C224B-DHR



ABS Bracket
DHR-ABSBKRT-AS



ABS Pressure Sensor Fitting
LCR-DH-BOSCH-ADP

Brakes

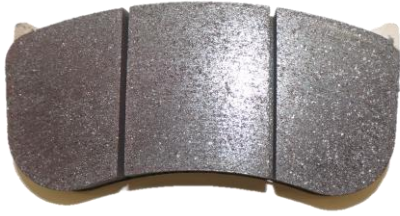

Front Brake Pad
BRP34-1980WA.29B



Front Brake Pad
BRP34-1980WA.29B



Front Caliper Bracket w/ Hardware
20B71805-A / 20B71805



Front Caliper - LH / RH
XB8GK51 / XB8GK52



Front Brake Backing Plate LH / RH Kit
DHR-BRAKE-BKNG-PLT-L / R



Rear Brake Pad Kit
P1309.17.F01

Brake Disc Assembly



Brake Disc Assembly
70C-9006LK (LH) / 70C-9006RK (RH)



Bell Ring Bolts
5582916



Bell Ring
05A46739



Disc
759B97936 (LH) / 759B97946 (RH)



Bell
16B71452

SS Brake Lines



Master Cylinder to ABS – Front
DHR-BRKLIN1



Master Cylinder to ABS – Rear
DHR-BRKLIN2



Rear Brake Lines, ABS to Rear LH
DHR-BRKLIN3



Rear Brake Lines, ABS to Rear RH
DHR-BRKLIN4

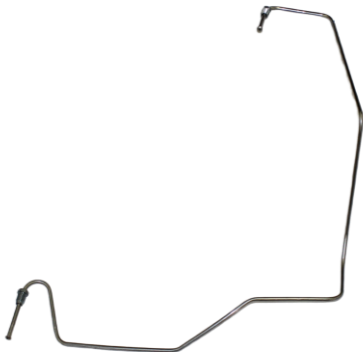

Front Brake Line – LH
DHR-BRKLIN5



Front Brake Line – RH
DHR-BRKLIN6

Flexible Brake Lines

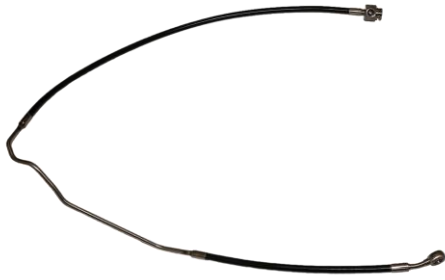

Rear Brake Line – LH
FORDM-B01

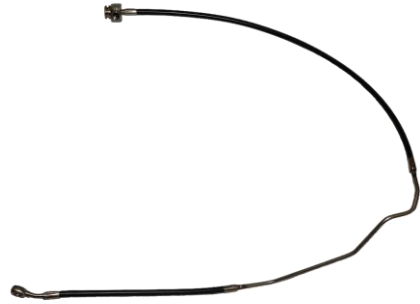

Rear Brake Line – RH
FORDM-B02



Front Brake Line – LH
FORDM-B05



Front Brake Line – RH
FORDM-B04



Front Brake Line Caliper Fitting / Copper Washer
06.2196.13 / 06.3710.20



Master Cylinder Fitting
9183-MTN

Driveline



Drive Shaft Loop Kit – Front
CM-5478-MGTF



Drive Shaft Loop Kit - Rear
CM-5478-350S-R



Differential Pump
GEN_GC1111



Bracket (Diff Pump to Body)
DHR-DIFFPMPBRKT-AS



Differential Cooler and Fan Unit
SETFP920M22I



Differential Cooler and Fan Unit Bracket
DHR-DIFF-CLR-BRKT



Filter Screen for Differential Cooler
SET11-UF08



Shifter Kit
LCR-7210-A

Driveline

Optional



Shifter
FR-7210-DHR

Optional



Shifter Knob
LCR-7210-B

Driveline – Half Shafts



Half Shaft LH
DHR-HALFSHAFT-MODLA



Half Shaft RH
DHR-HALFSHAFT-MODRA



CV Boot – LH
M-3A331-GT4A



CV Boot – RH
M-3A331-GT4B

CV Boots can be used for both inboard and outboard locations

Driveline – Clutch



Clutch Pressure Plate
FP-7563-DHRA



Disc
FP-7550-DHRA



Flywheel
FP-6375-DHR



Throwout Bearing
MR3Z-7A508-A



Pressure Plate Hardware
(Included in FP-6375-DHR)



Clutch Spacer Kit
FP-7500-DHR



SS Clutch Line
S650-DHR-CLUTCH-LINE



Clutch Master Feed Kit
LCR-CMFK-DH

Driveline – Cooling Lines

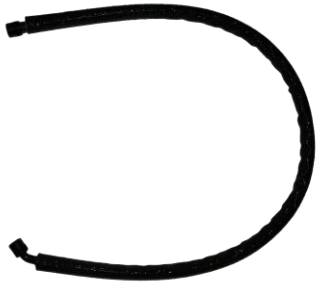

Differential Cooler Line, LH Cooler Out / Differential In
S650-DHR-DIFF-LINE-HOSE1



Differential Cooler Line, Pump Out / RH Cooler In
S650-DHR-DIFF-LINE-HOSE2



Differential Cooler Line, Differential to Pump In
S650-DHR-DIFF-LINE-HOSE3A



Differential Cooler Line, RH Cooler Out / LH Cooler In
S650-DHR-DIFF-LINE-HOSE4



Oil Cooler Line, Transmission In
DHR-TRNS-CLR-LIN-1A / DHR-TRNS-CLR-LIN-1



Oil Cooler Line, Transmission Out
DHR-TRNS-CLR-LIN-2A / DHR-TRNS-CLR-LIN-2



Transmission Oil Cooler Line
FR-6B850-DHR



Transmission Oil Cooler Tube Assembly
FR-7R081-DHR

Driveline – Catch Cans



Front Catch Can Kit – Transmission
DHR-FCTCHCAN-TRANS
(Optional for Chassis 001-040)

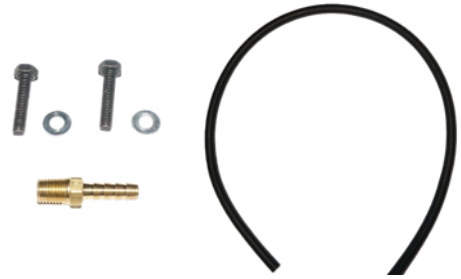

Rear Catch Can Kit – Differential
DHR-RCTCHCAN-DIFF
(Optional for Chassis 001-040)



Catch Can
JOES-12310
(Optional for Chassis 001-040)



Transmission / Differential Vent
MR3Z-7A246-B
Standard for Chassis 001-040

Transmission – Seal Locations

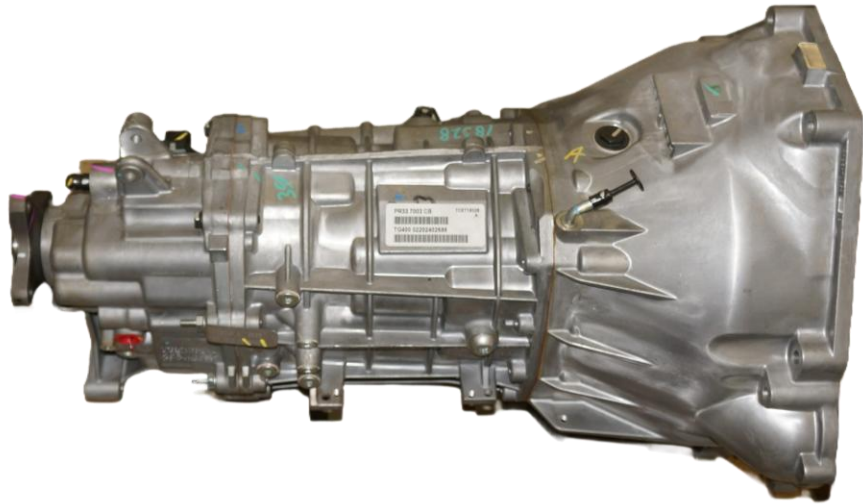

Sealed Transmission
FP-7003-DHR / FR-7003-DHR1

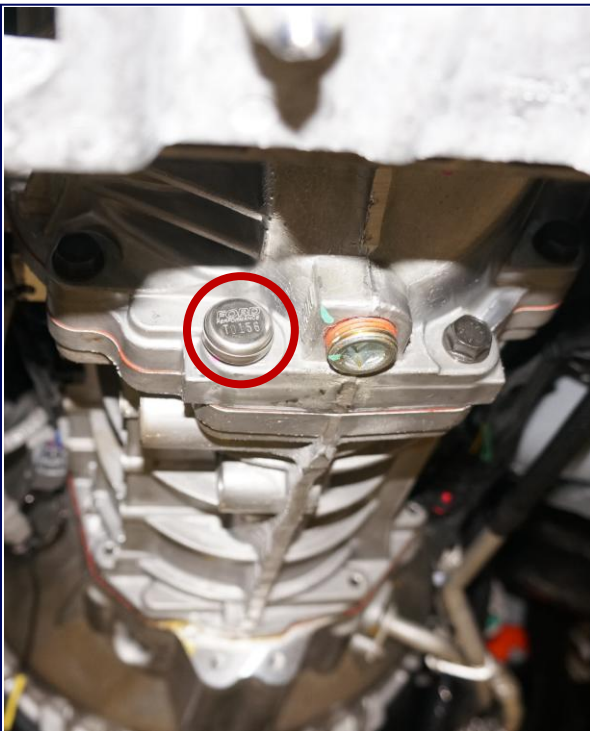

Transmission Seal Location 1

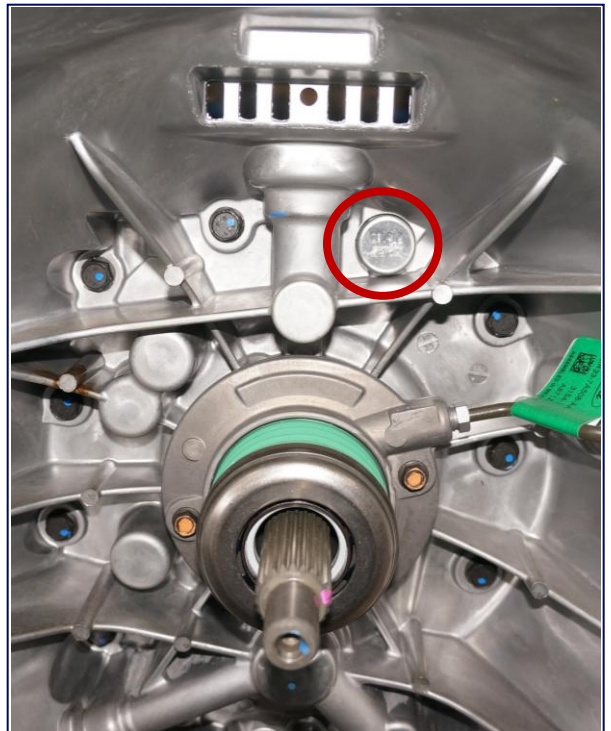

Transmission Seal Location 2
Inside Bell Housing

Rear Axle – Seal Location

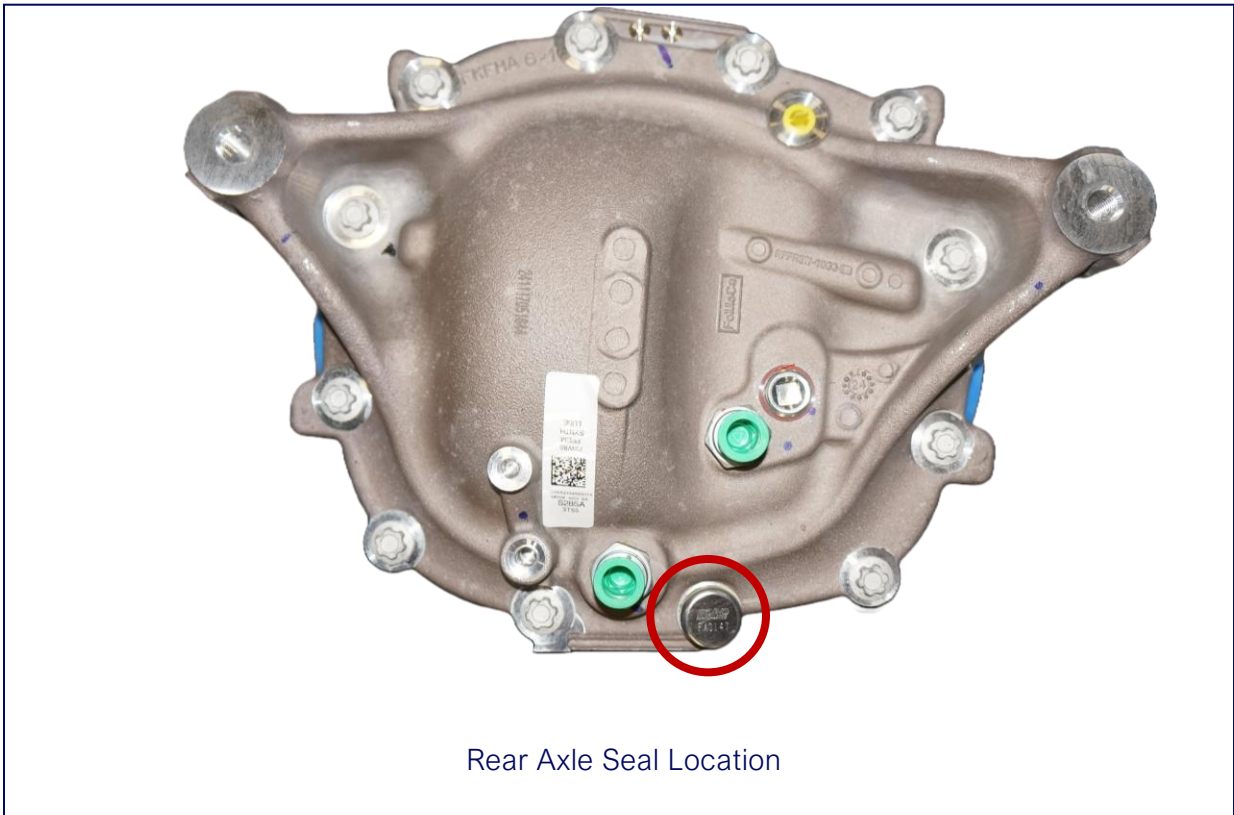
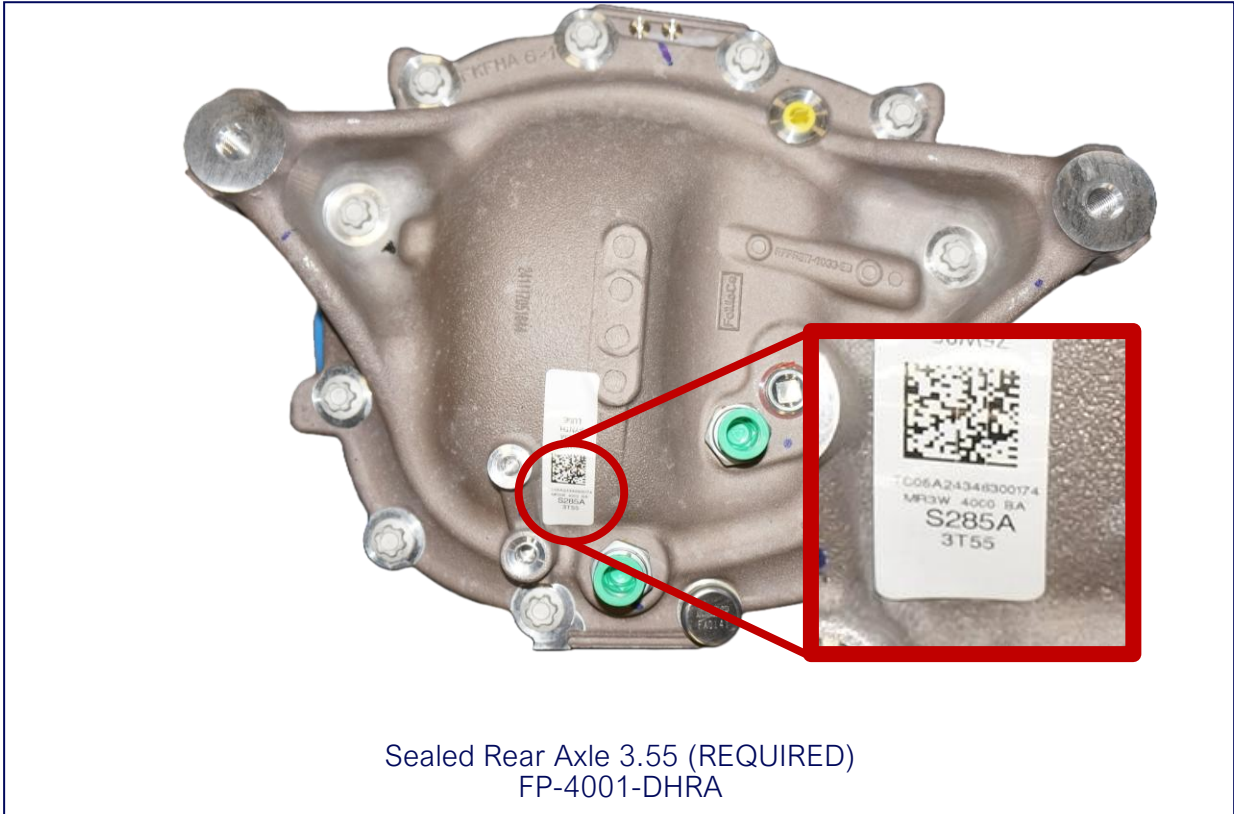

Steering



Quick Release w/ Hardware
015R98TU



Steering Wheel
M-3600-RA



Multifunction Switch
DHR-CLMNSWTCB-MOD



Steering Hub
01502067CA



Steering Wheel Hook
JOES-10704-B

Wheel & Tires – Required for Mustang Challenge NA Required for Mustang Cup AU

MICHELIN



Tire – Slick
79759

MICHELIN



Tire – Rain
25100



Wheel
VS5RE1811ET52-AN



Wheel
VS5RE1811ET52-AN



Wheel Spacer
APX-SPCR-5114-28-B

Wheel & Tires – Required for Mustang Cup USA

 YOKOHAMA.



Tire – Slick
150100683

 YOKOHAMA.



Tire – Rain
150100722



Wheel
VS5RE1811ET52-AN



Wheel
VS5RE1811ET52-AN



Wheel Spacer
APX-SPCR-5114-28-B

Data



Data System, MC187
M C187 Dark Horse R



Data System GPS Antenna
M GPS-L10



Bracket (Mount Screen to Clock Spring)
DHR-MOTECBRKT



ProCal 4
M-12655-F



Oil / Trans Temperature Sensor
M 25-2197D

Optional



Shift Light Module
18120

Electrical



Battery/Underhood Harness, Modified
PR3T-14B060-PGMOD



Battery to Breaker Cable
FP-14B060-AA



Breaker to Relay Cable
FP-14B060-BA



Underhood/PDB Harness, Modified
PR3T-14290-FHLMOD



Instrument Panel Harness, Modified
PR3T-14401-EFMOD



Front Loom
FP-14290-AB



Main Body Harness, Modification
PR3T-14A005-CGLBMOD



Cockpit Loom
FP-14A005-AB

Electrical



Switch Panel / Switch Panel Harness
DHR-CENTERSTACK / FP-14401-BA



Master Power Panel / Upper Interior Switches
DHR-MSTR-PWR-PNL / FP-14401-CB



Steering Wheel Switch Plate / Steering Wheel Harness
DHR-STRNGWHLSWTCH / FP-14A664-AA



Rear Harness
PR3T-2B572-FFMOD



RH Door Harness
PR3T-14630-HGMOD



LH Door Harness
PR3T-14631-KGMOD



Diff Pump Jumper Harness
FP-14A411-AA



Fuel Pump Jumper Harness
FP-2B572-AA

Electrical



Main Breaker
Optifuse 353250



Relay
TE 29-311-11



Can Bridge Module
M-14660-2FD
(Standard for Chassis 001-040)



Can Bridge Module
M-14660-3FD
Standard for Chassis 041+
(Optional for Chassis 001-040)

Required – Mustang Challenge NA
Optional – Mustang Cup USA & AU



Battery Hold Down Kit
LCR-DH-BHDK

Driver's Seat – Required for Mustang Cup USA & AU



Seat, Recaro Pro Racer SPG XL
071.38.0630-01



Seat Bracket, Recaro Flexible Side Mount XL
7206293NA



Seat Brackets, Recaro Steel Side Mounts
7207450ANA



Seat Bracket, Recaro Flexible Side Mount
7221002NA



Seat, Recaro Pro Racer SPG
071.28.UU11-01

Driver's Seat – Required for Mustang Challenge NA Optional for Mustang Cup USA & AU



Seat, ADV-XT
008032FNR



Seat Brackets
004932L

Driver's Seat – Optional for Mustang Challenge NA Optional for Mustang Cup USA & AUS



Seat, Spine XL
RFSESPINEBASE



Seat Brackets, F12
RFST0071



Seat Padding Kit (M, L, XL)
RCSPINEPADM, RCSPINEPADL, RCSPINEPADXL

2024 Seat Mount Configuration

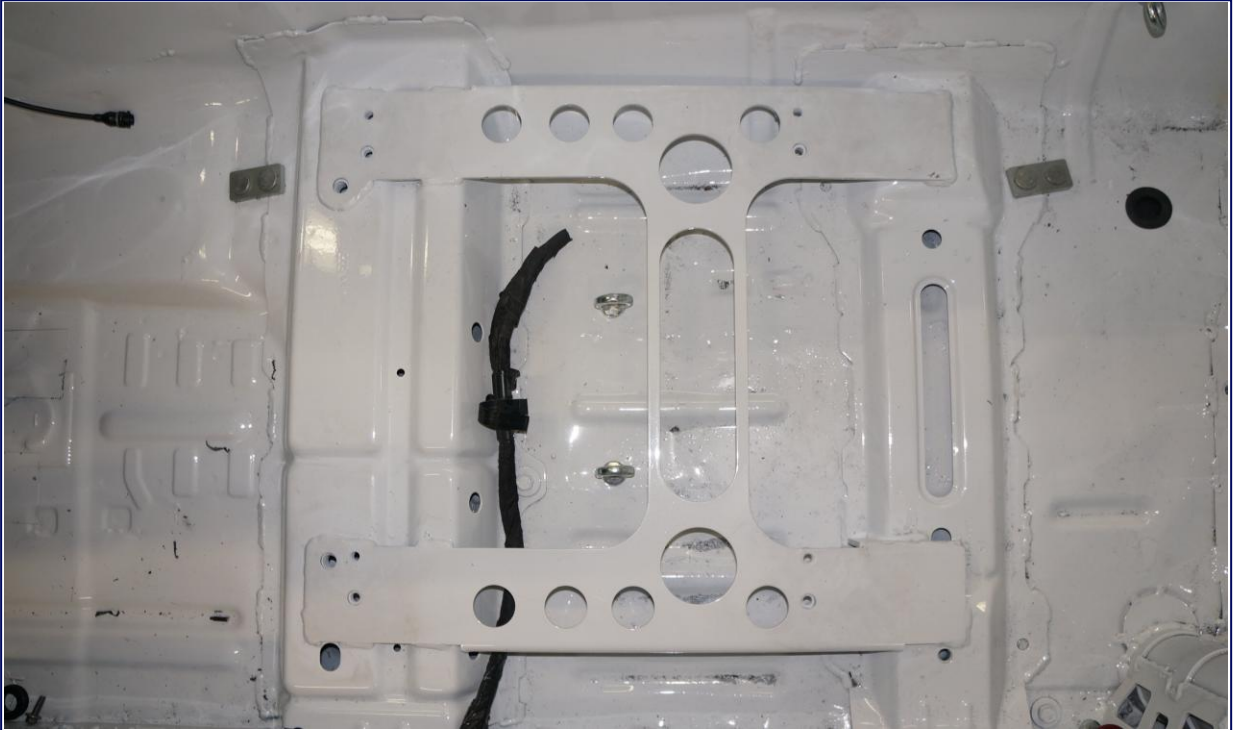

Standard Seat Mounting Plate for Chassis 001-040

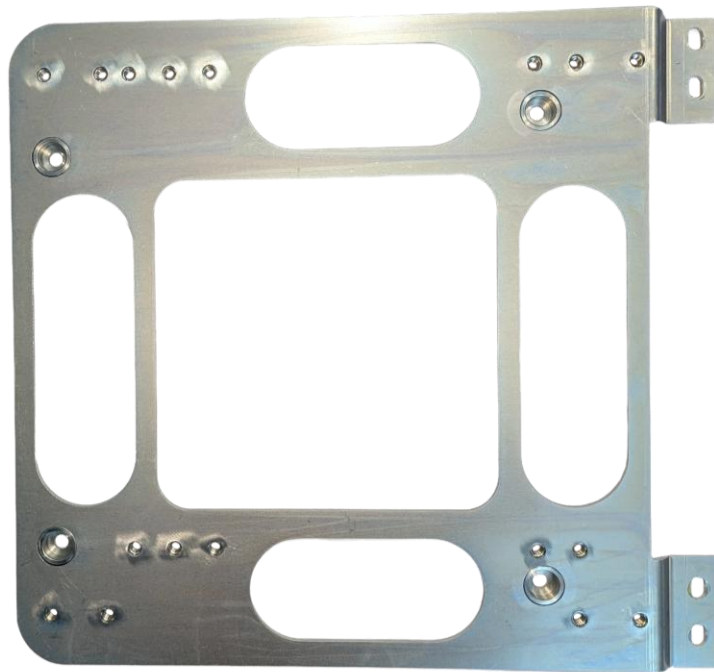

2026 Seat Mount for 2024-2025 Seat Mounting Configurations
FR-61704-A

2025 Seat Mount Configuration



Standard Seat Mounting Plate for Chassis 041-120
(Optional for Chassis 001-040)

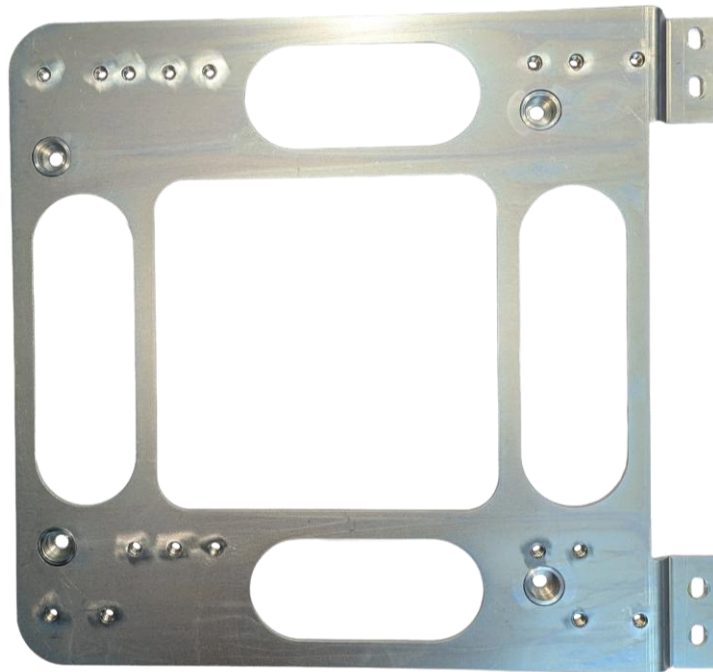

2026 Seat Mount for 2024-2025 Seat Mounting Configurations
FR-61704-A

2026 Seat Mount

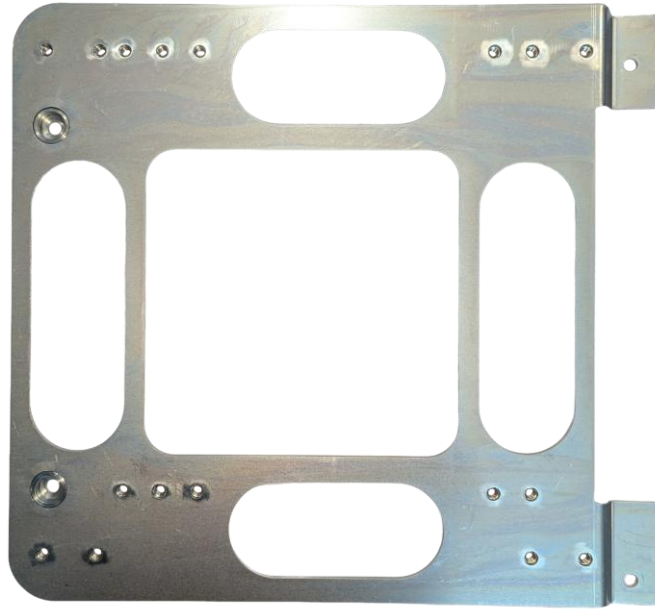

2026 Standard Seat Mount

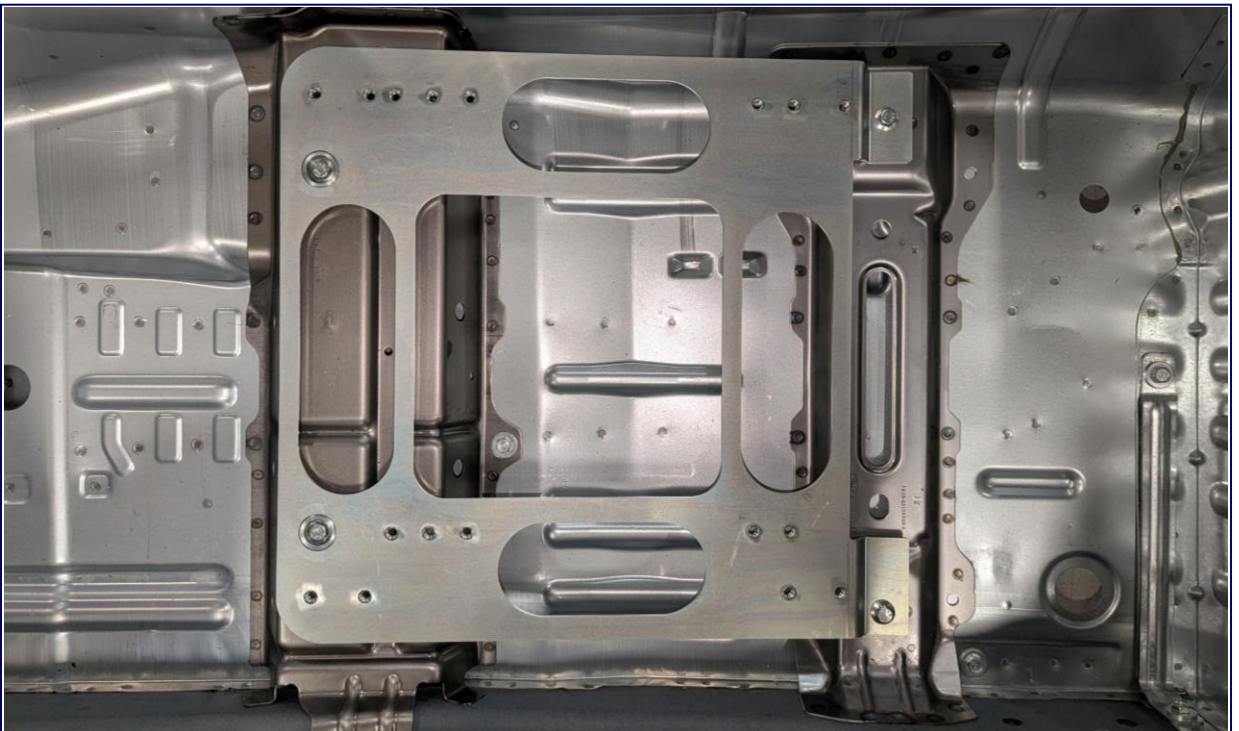

2026 Standard Seat Mount
FR-61704-B

Safety Equipment – Fire Suppression System



Fire Bottle / Mount
014772MSL

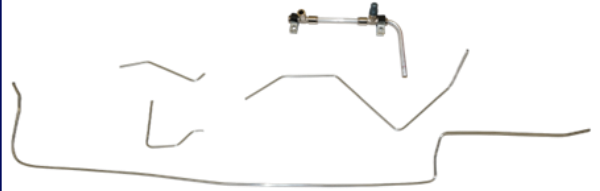

Fire Suppression Lines
014772MSL



Fire Suppression System Fittings / Nozzles
014772MSL



Fire Suppression System Pull Cable
014772MSL

Safety Equipment



Driver Safety Harness
SAB-CFCI22100056



Roll Bar Padding
BSCI-78001



Window Net Mounting Kit
DHR-NETHRDWR

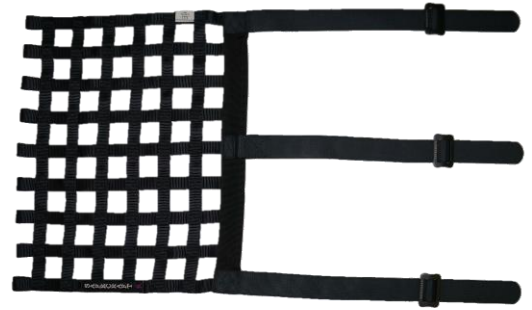

Driver Window Net
LCR-DH-LHWN

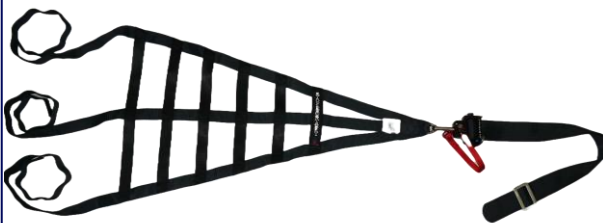

Helmet Support Net, Right Side
SFC-8011-K-FIA

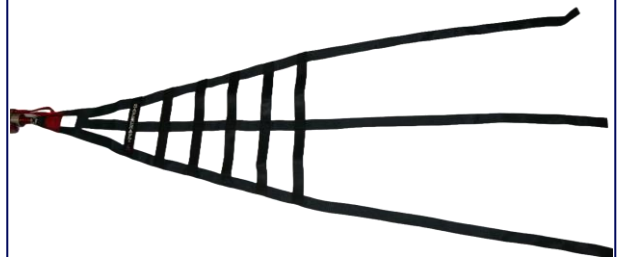

Helmet Support Net, Left Side
SFC-8111-K-L-FIA

Window Nets



RH Helmet Support Net (Ratchet Release)
Mounting Points

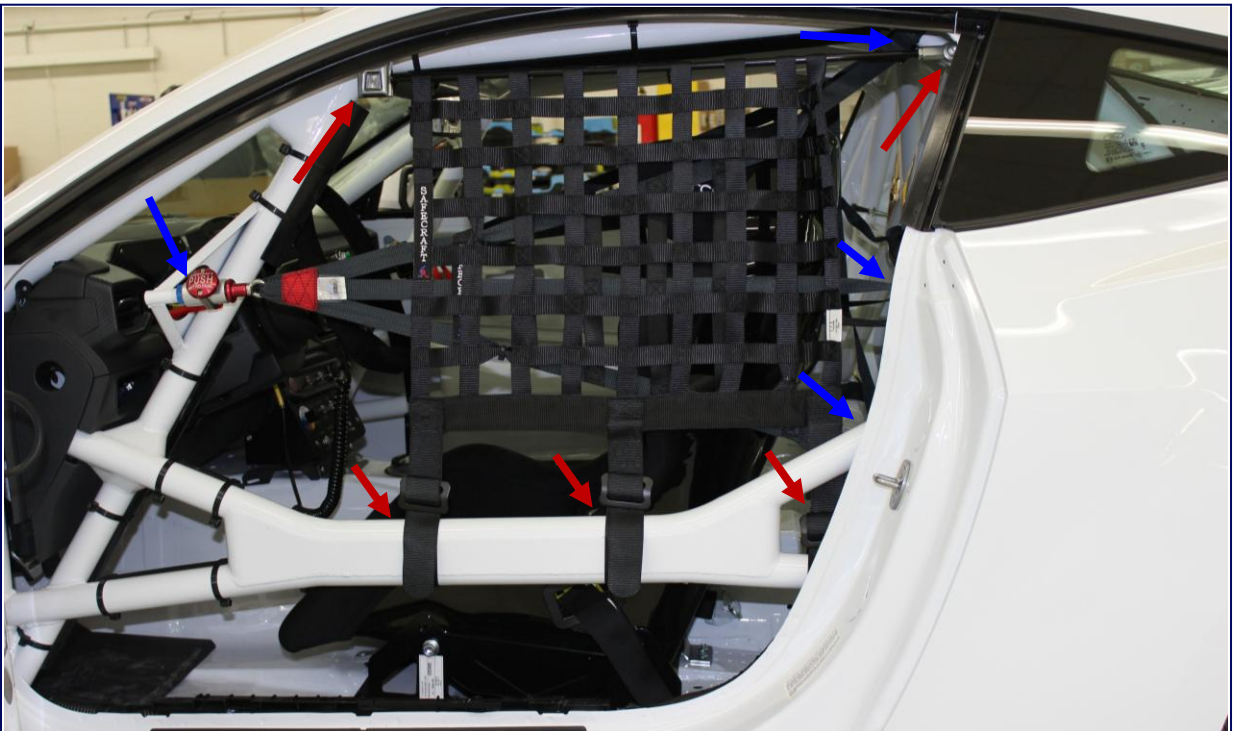

LH Driver Window Net + Helmet Support Net (Quick Release)
Mounting Points

Window Nets

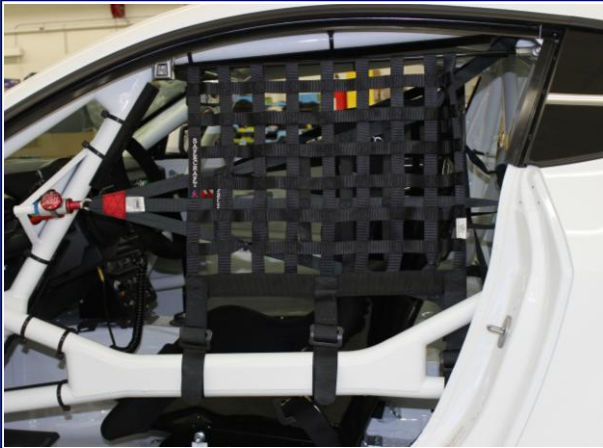

Driver Helmet Support Net Mounting Points



Driver Window Net Mounting Points



Driver Helmet Support Net Quick Release



Driver Window Net Rod Release



Driver Helmet Support Net Mounting Points



Driver Window Net Rod Mounting Point

Safety Harness and Helmet Support Net Collars

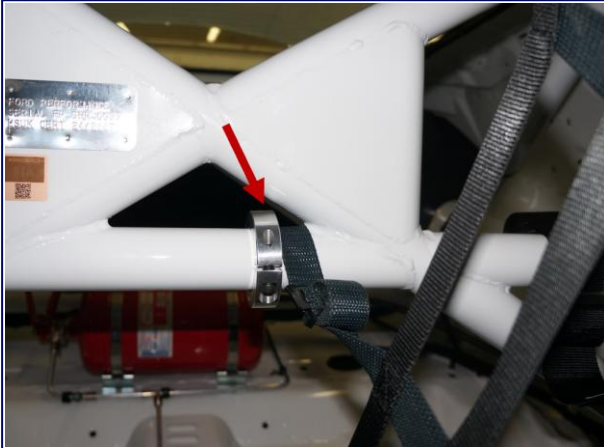

Helmet Support Net Collar Location
Main Safety Cage Center

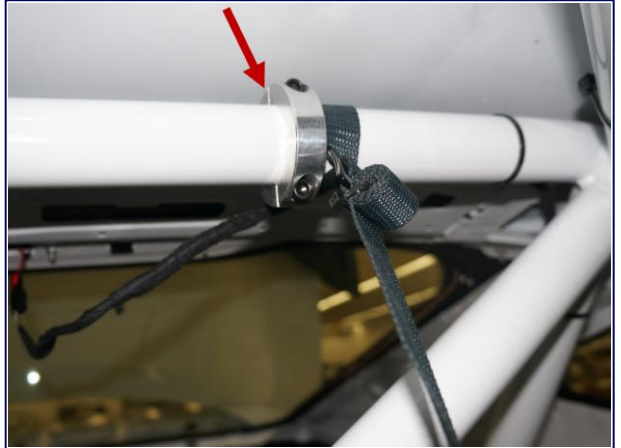

Helmet Support Net Collar Location
Main Safety Cage Hoop

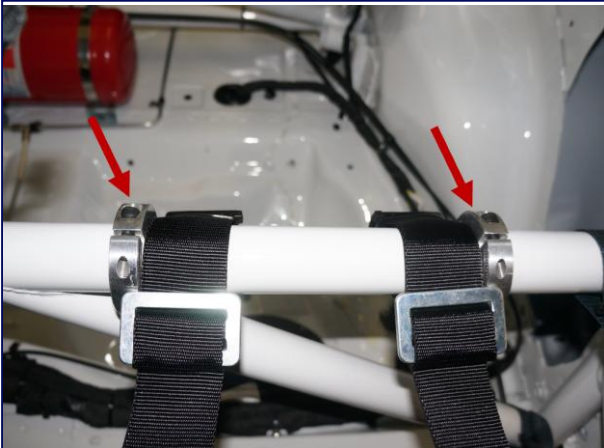

Safety Harness Collar Locations
Safety Cage Bar Behind Driver's Seat



2-Piece Lock Collar, 1.75in ID
GEN-GA3277

Roll Bar Padding



Roll Bar Padding Locations

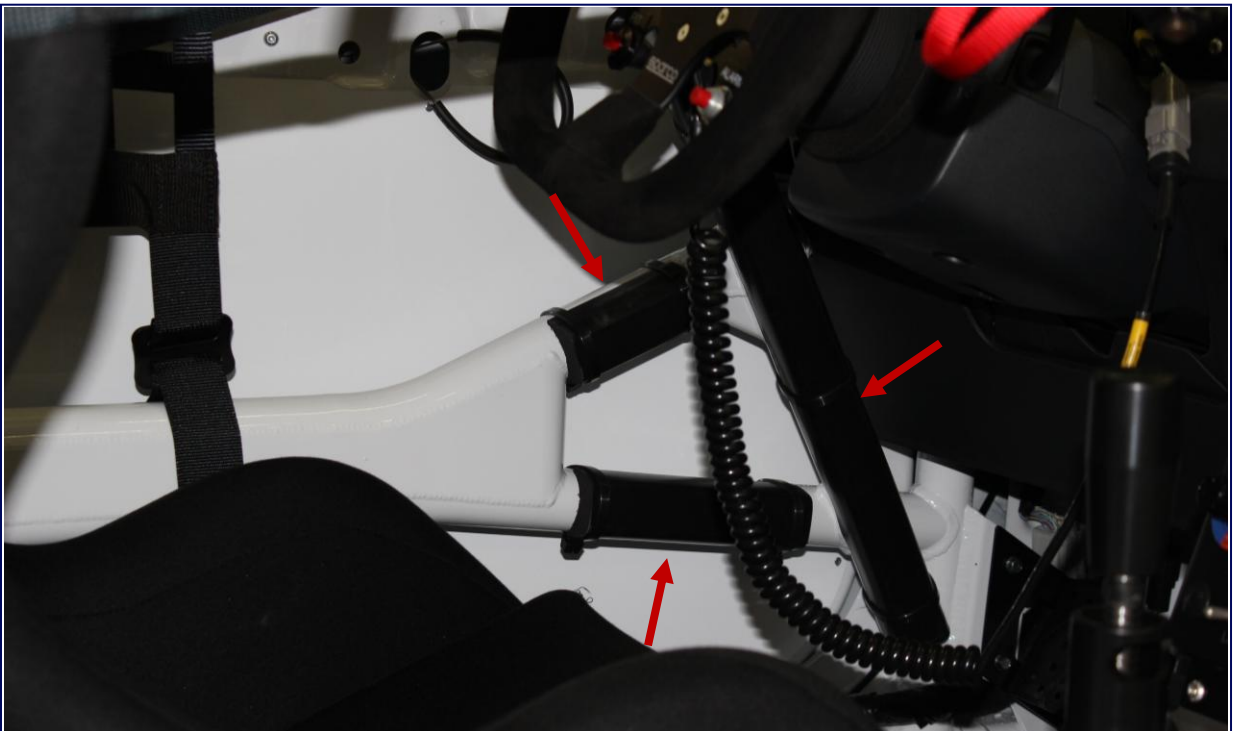

Roll Bar Padding Locations

Recommended Fluids



Motor Oil, Ford Motorcraft 5W-50
XO-5W50-QGT



Trans Fluid (Motorcraft Mercon LV)
XT-10-QLVC



Gear Lubricant, Ford Motorcraft 75W-85
XY-75W85-QL



Brake Fluid, Brembo HTC64
04816420

Under Hood / Trunk



Under Hood View



Trunk View

Interiors



Interiors – View from Driver's Door



Interiors – View from Passenger's Door

Front Wheel Well

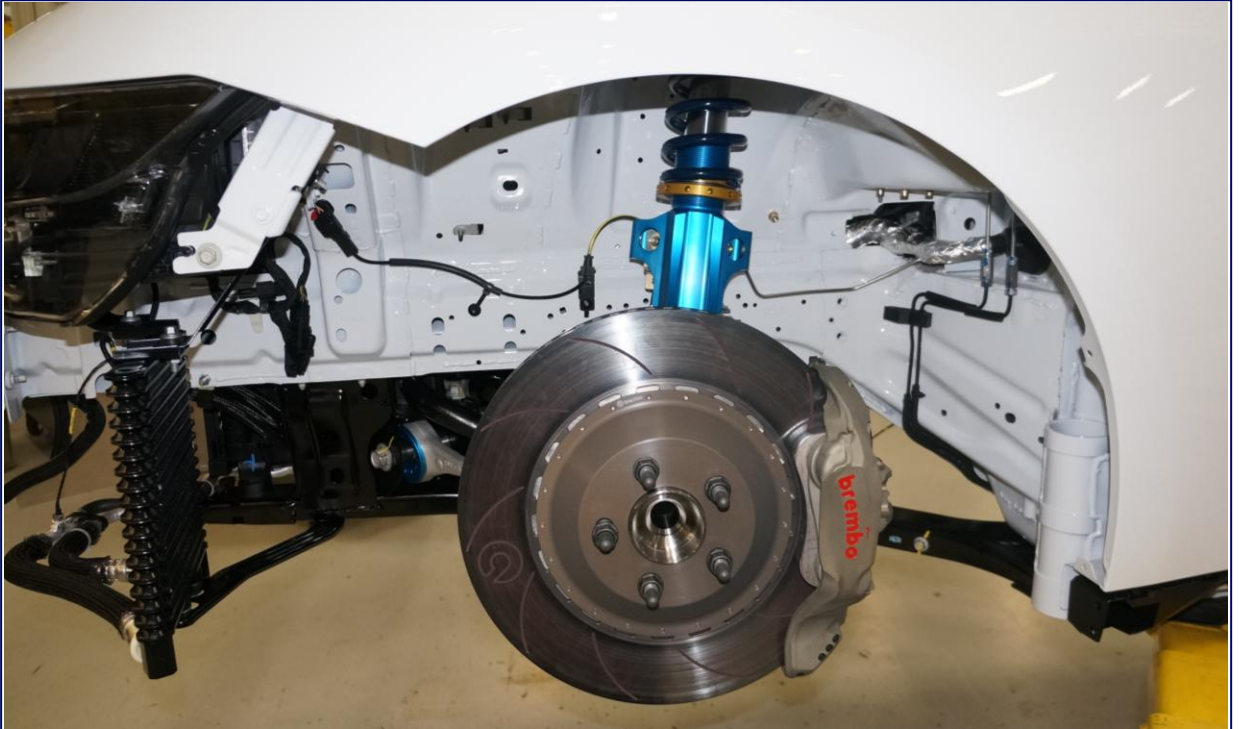

Front Driver Side Wheel Well

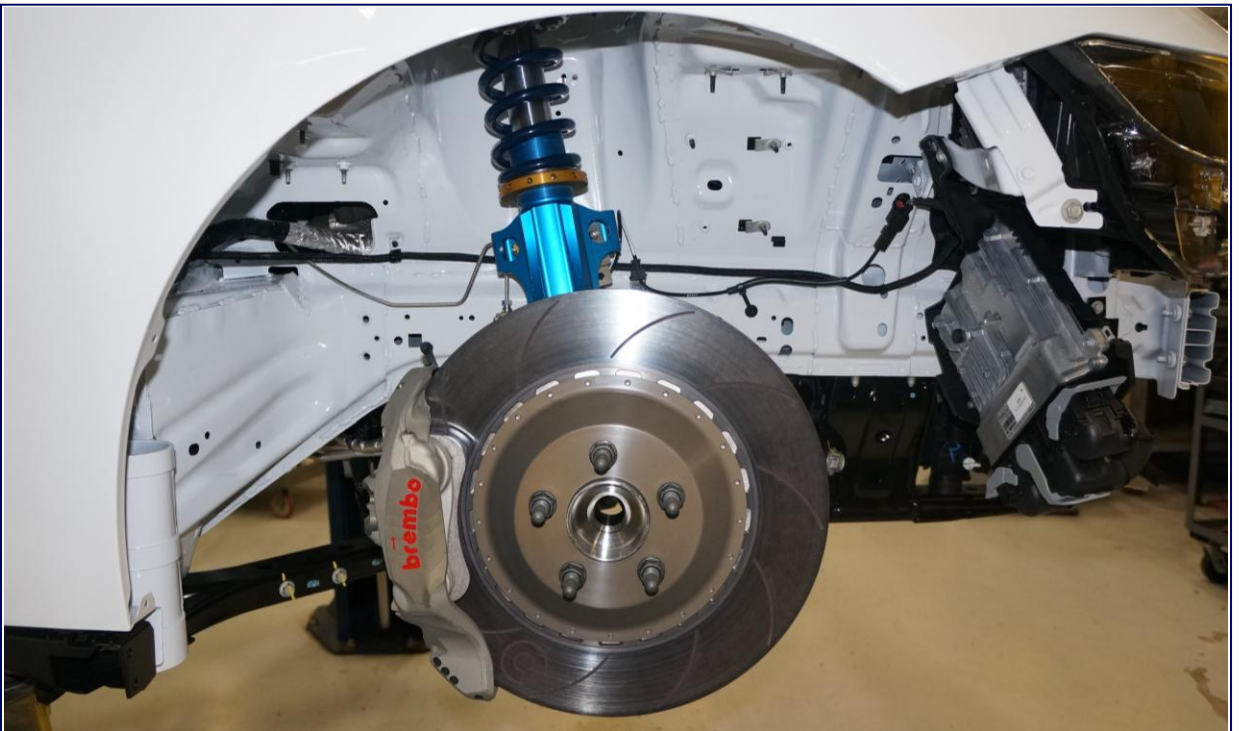

Front Passenger Side Wheel Well

Rear Wheel Well



Rear Driver Side Wheel Well



Rear Passenger Side Wheel Well

Body in White (BIW)



Caged BIW Mustang Dark Horse R
CFP-607100-DHRCP



Caged BIW Mustang Dark Horse R
CFP-607100-DHRCP

Chassis Serial Number



Chassis Serial Number – Windshield Tag Standard (As Delivered)



Chassis Serial Number – Windshield Tag BIW



Chassis Serial Number – Safety Cage Tag Standard (As Delivered)



Chassis Serial Number – Safety Cage Tag BIW



Safety Cage FIA Certification Standard (As Delivered)

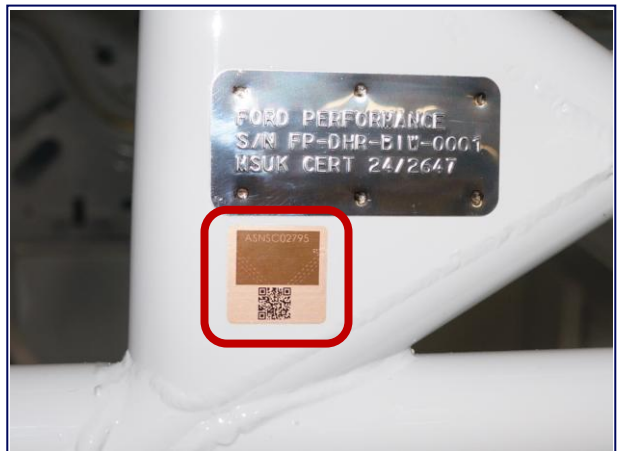

Safety Cage FIA Certification BIW

Appendix

Driver Safety Harness System



Harness Mounting Points
Roll Cage Behind Driver's Seat

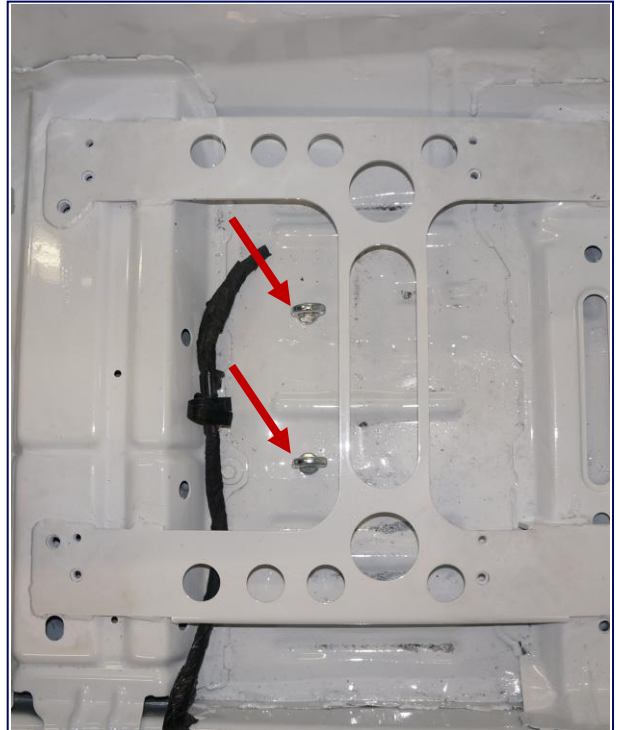

Harness Mounting Points
Driver's Side Floor



Harness Mounting Point
Driver's Side Rear

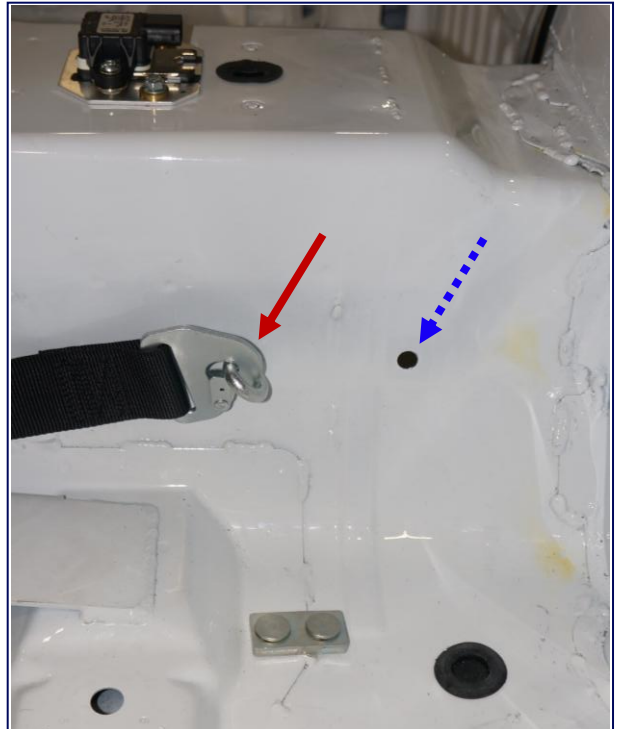

Standard Harness Mount Location (Red)
Optional Harness Mount Location for use with Inboard Seat
Mount Location (Blue Dashed)
Left Side of Drive Shaft Tunnel

Master Power Electrical Switch



Interior Master Power Electrical Switch
OFF – Down towards Floor / ON – Up towards Roof



Exterior Master Power Electrical Switch
Exterior Driver Side
OFF – towards Passenger Side / ON – towards Driver Side

Fire Suppression System

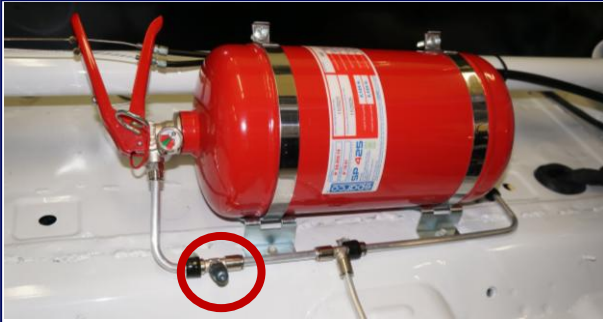

Fire Bottle Mount + Nozzle



Driver's Feet Nozzle

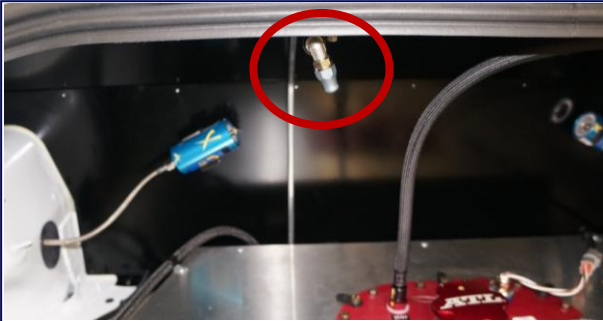

Fuel Cell Nozzle



Engine Bay Nozzle 1
Driver Side



Engine Bay Nozzle 2
Passenger Side

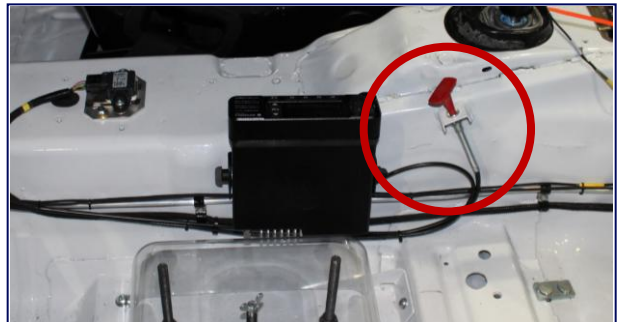

Interior Cable Pull
Right Side of Drive Shaft Tunnel



Exterior Cable Pull
Exterior Driver Side



Air Jack System – Optional



Air Jack Bezel
13052-09-1110 (Qty: 1)



Krontec Connecting Valve
KR0.LL.16 or KR0.LL.16PLUS (Qty: 1)



Krontec Air Lift
Std. 60mm M60 X 1.5 HUB 230 mm
KR0.LL.24 (Qty: 4)

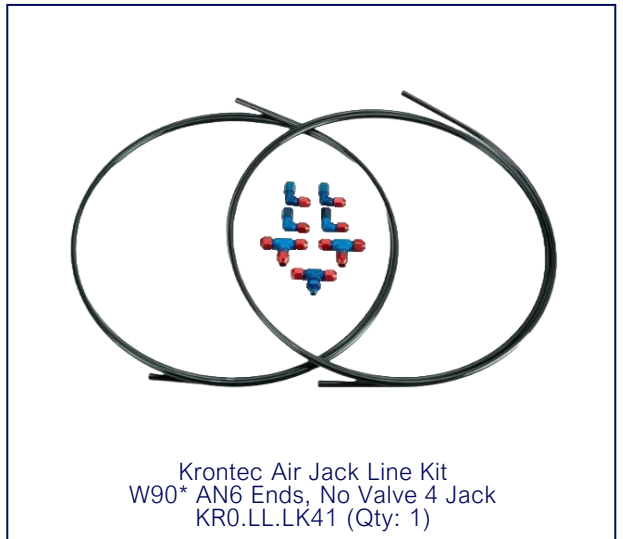

Krontec Air Jack Line Kit
W90* AN6 Ends, No Valve 4 Jack
KR0.LL.LK41 (Qty: 1)

Use routing locations as shown in this document.
Connection valve location is open.

Air Jack System – Optional

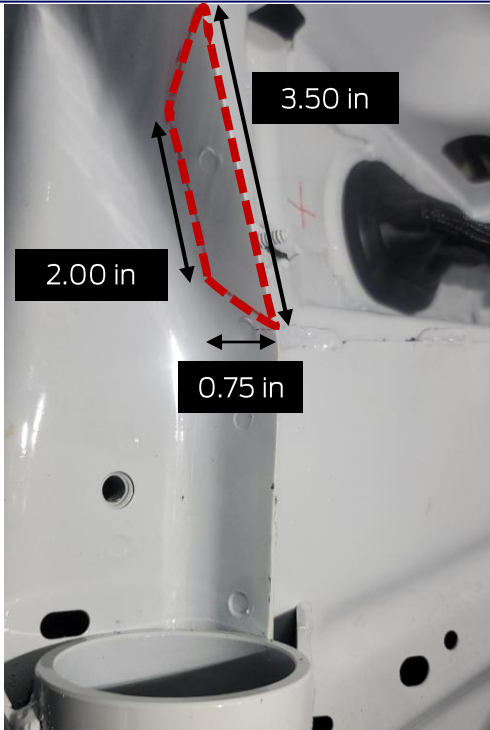

Front Seam Modification
Passenger Side Shown, Driver Side Opposite

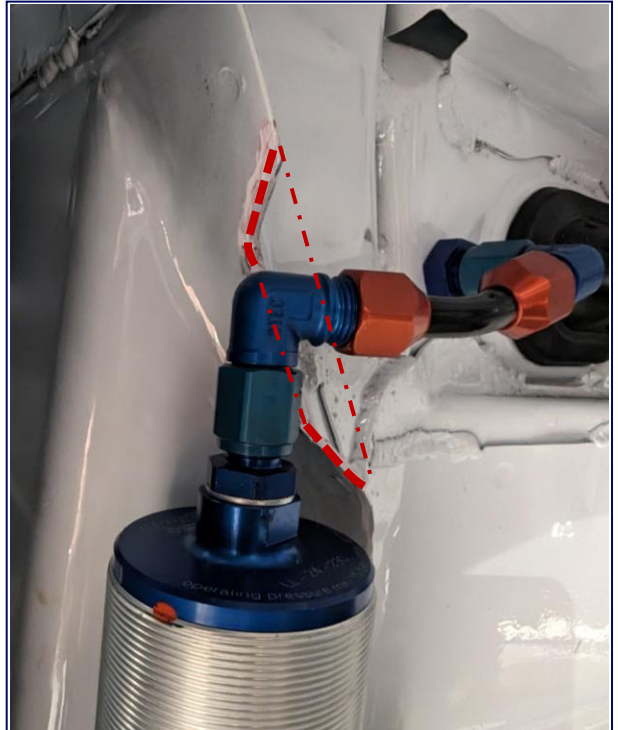

Front Seam Modification
Passenger Side Shown, Driver Side Opposite



Front Air Jack / Bulkhead Connection
Passenger Side



Front Air Jack / Bulkhead Connection
Driver Side

Air Jack System – Optional

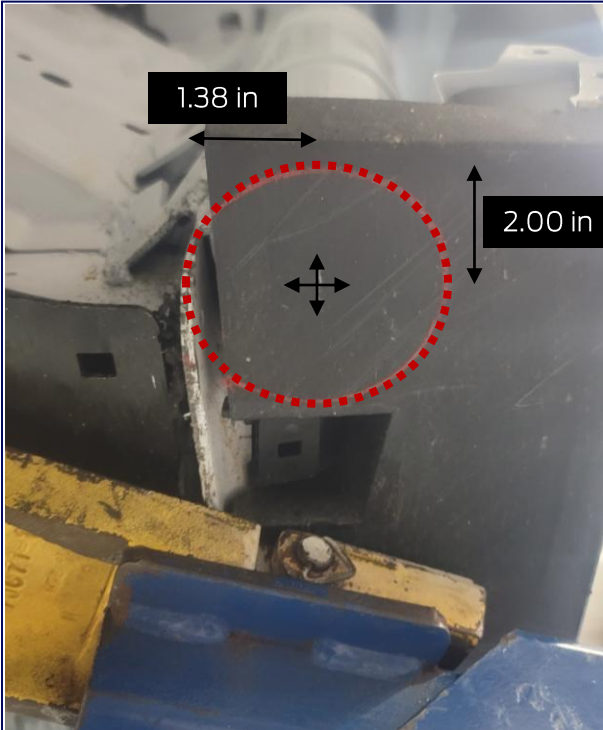

Front Air Jack Side Skirt Modification
Driver Side Shown / Passenger Side Opposite

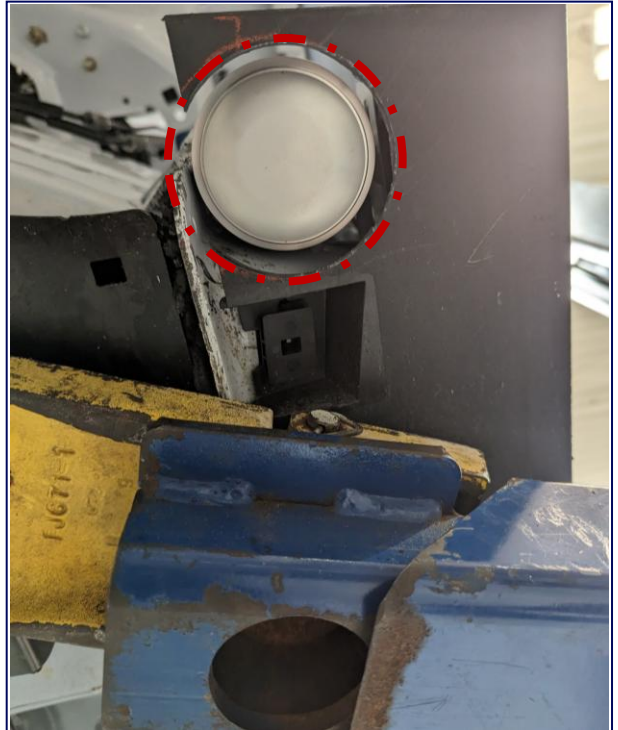

Front Air Jack Side Skirt Modification
Driver Side Shown / Passenger Side Opposite



Rear Air Jack
Driver Side

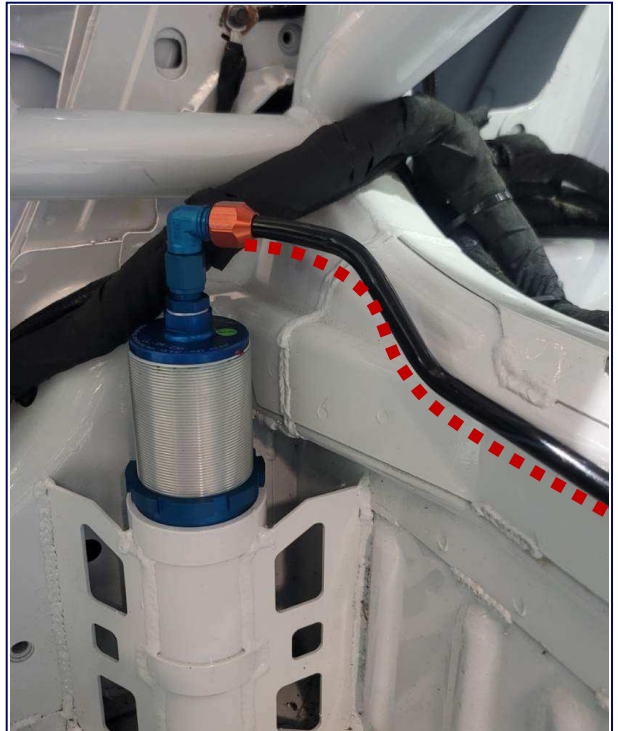

Rear Air Jack
Passenger Side

Air Jack System – Optional

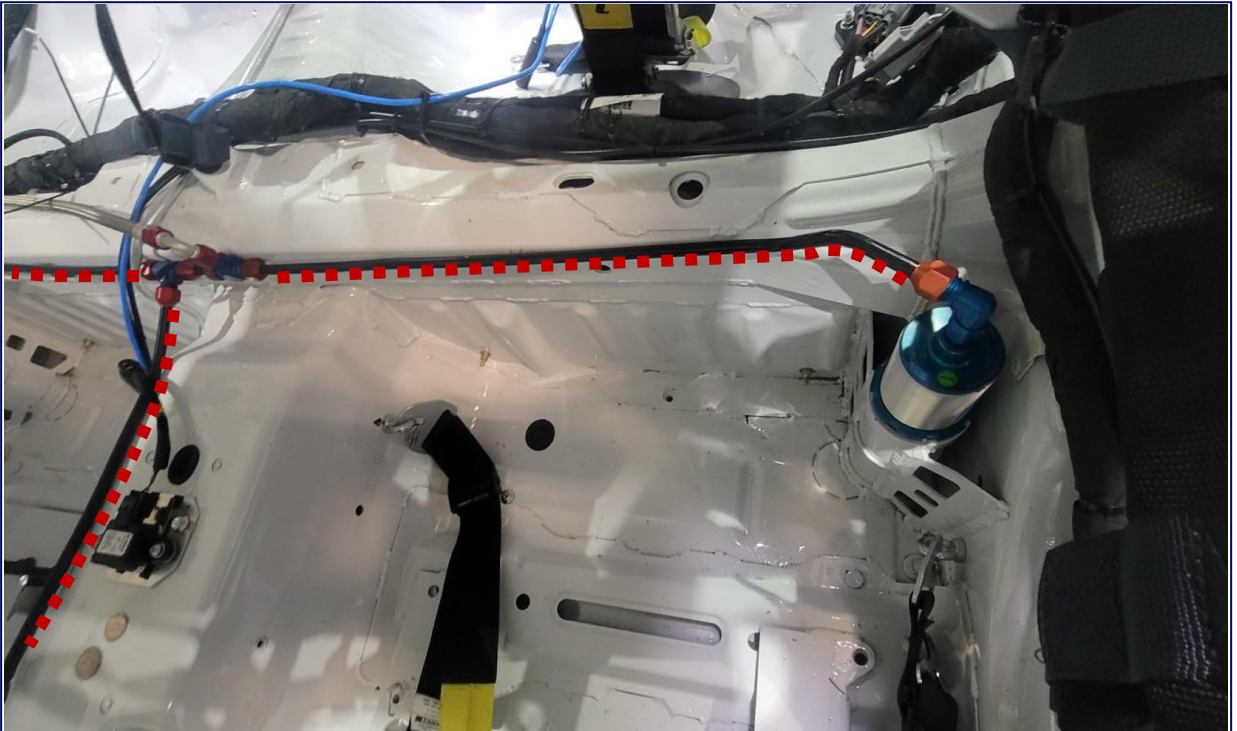

Rear Air Jack / Routing
Driver Side

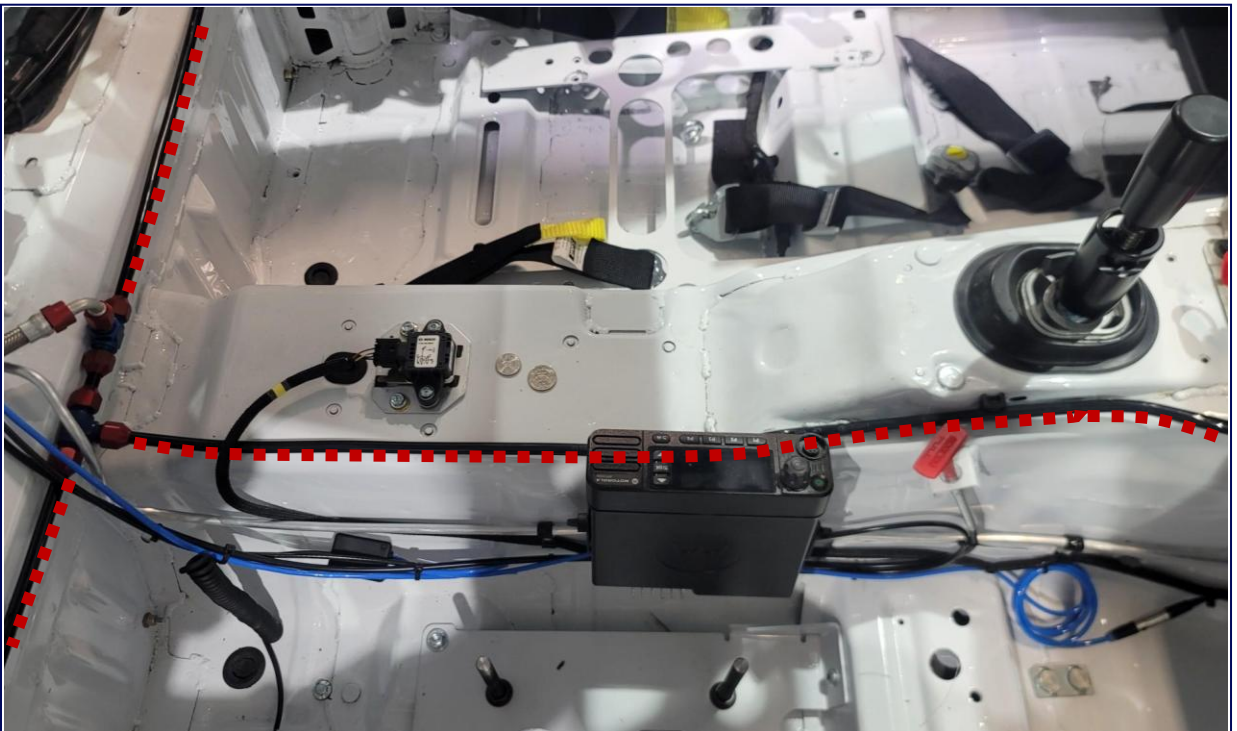

Air Line Routing
Passenger Side of Transmission Tunnel

Air Jack System – Optional

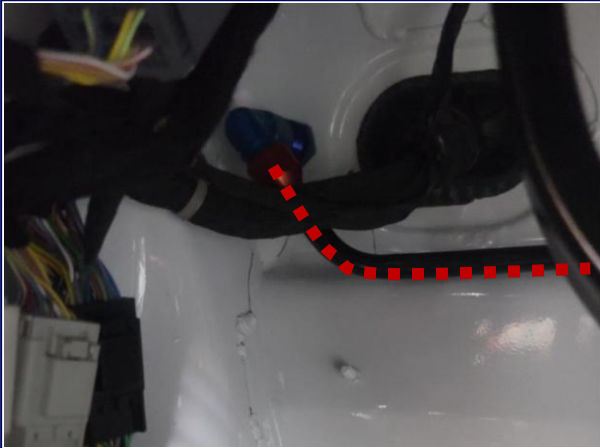

Front Air Jack
Driver Side



Front Air Jack Line Routing
Driver Side

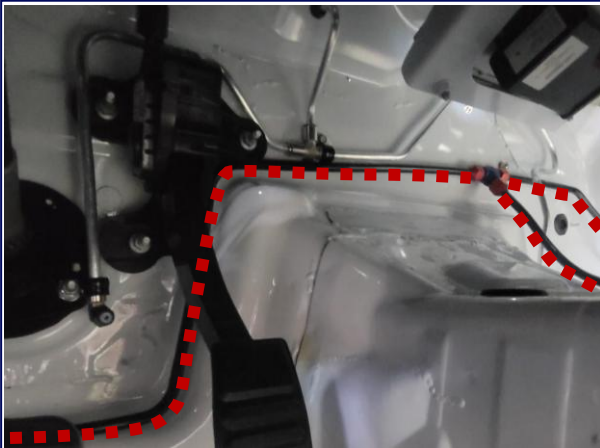

Front Air Jack Line Routing
Driver Side

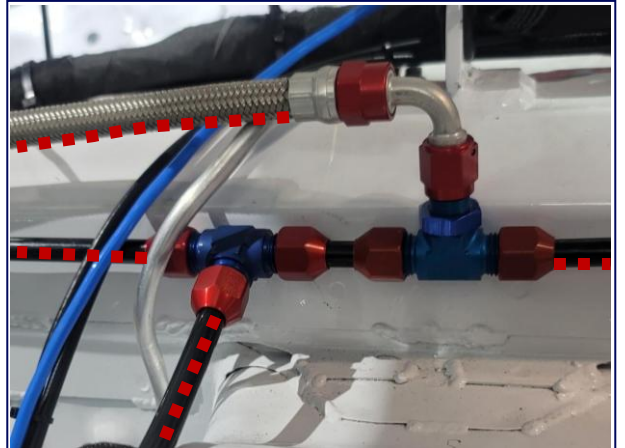

Airline Union to Rear Air Jacks / Air Feed
Line Junction

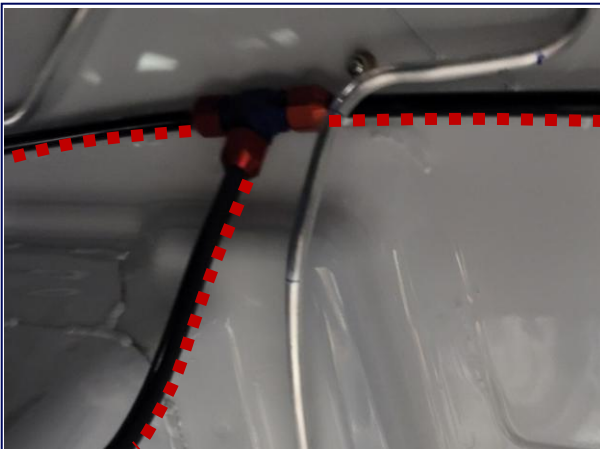

Front Air Jack Union
Union of Passenger Side and Side of Transmission Tunnel

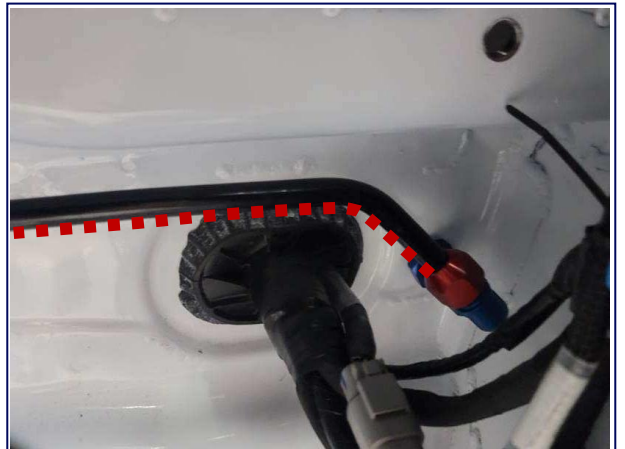

Front Air Jack
Passenger Side

Radio



Radio Location
Right Side of Drive Shaft Tunnel



Radio Mounting Location
(2) M6 Rivnuts Provided



Radio Antenna Location
Driver's Side Roof Panel

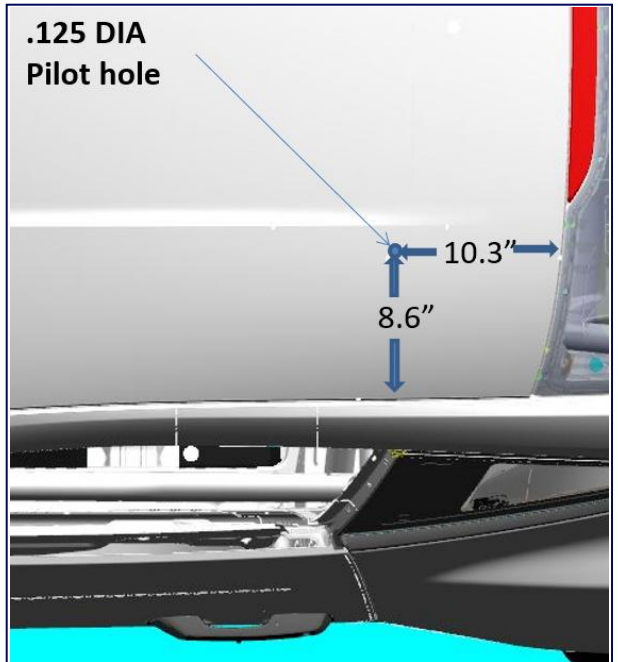

Radio Antenna Location Diagram
(a 1/8" pilot hole is provided)

Yellow Flag Warning System – Mustang Challenge NA



Light Location
Dash Closeout

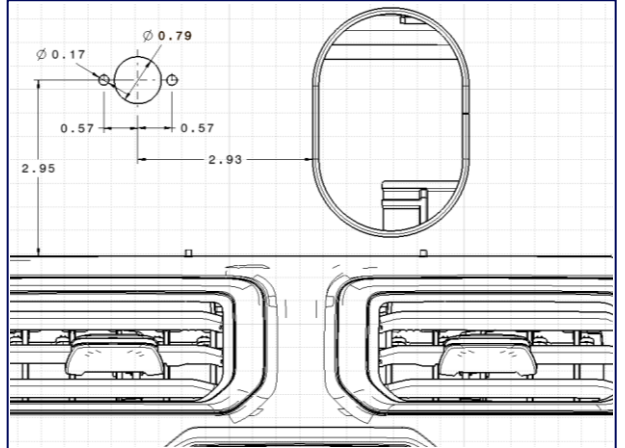

Panel Cut Diagram for Light
(all dimensions are in inches)



Antenna Location
Passenger Side Roof

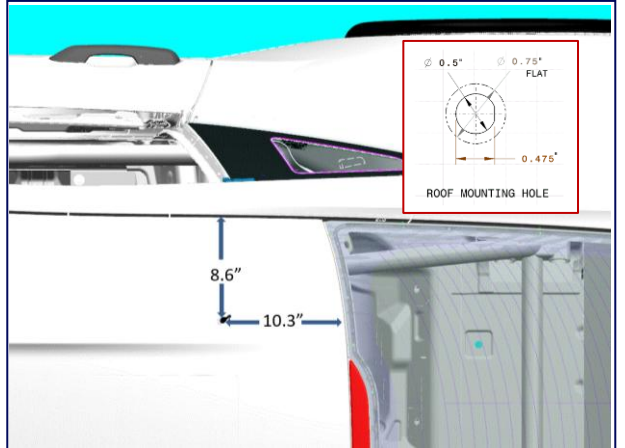

Antenna Location Diagram
(a 1/8" pilot hole is provided)

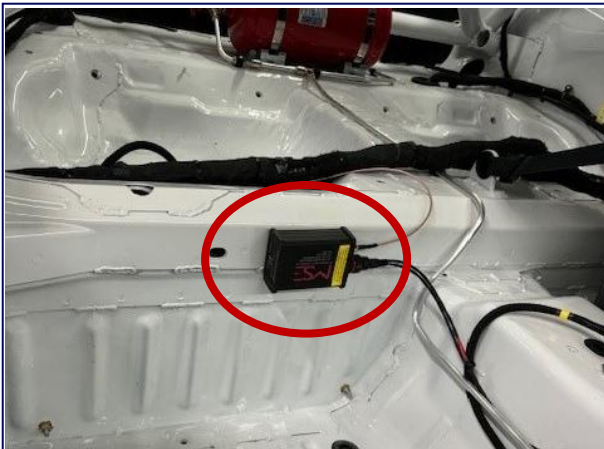

MSE Box Location
Passenger Side Waterfall

Safety System – Mustang Cup USA



Safety System Location
Passenger Side Roll Cage

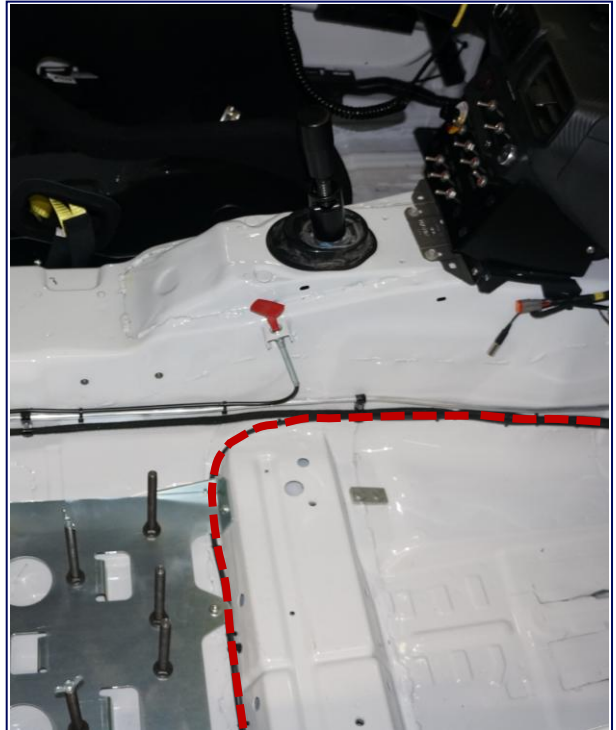

Safety System Routing Location
Passenger Side

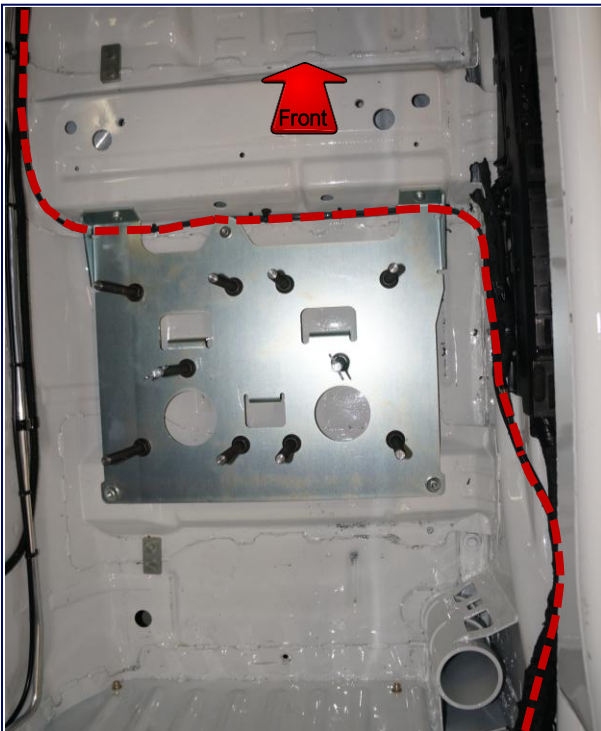

Safety System Routing Location
Passenger Side



Safety System Routing Location
Passenger Side

Safety System – Mustang Cup USA



Yellow Light Mounting Location
Dash Panel Closeout

Transponder



Transponder Location
Front Passenger Side



Transponder Location



Transponder Bracket Location
Front Passenger Side



Transponder Bracket
DHR-LAPSBKRT

Transmitters – Mustang Cup AU

Required



Transmitter, Power Sourced
Dorian VP16000

Optional



Transmitter, with Rechargeable Battery
Dorian Micro16000

Incident Data Recorder – Mustang Challenge NA

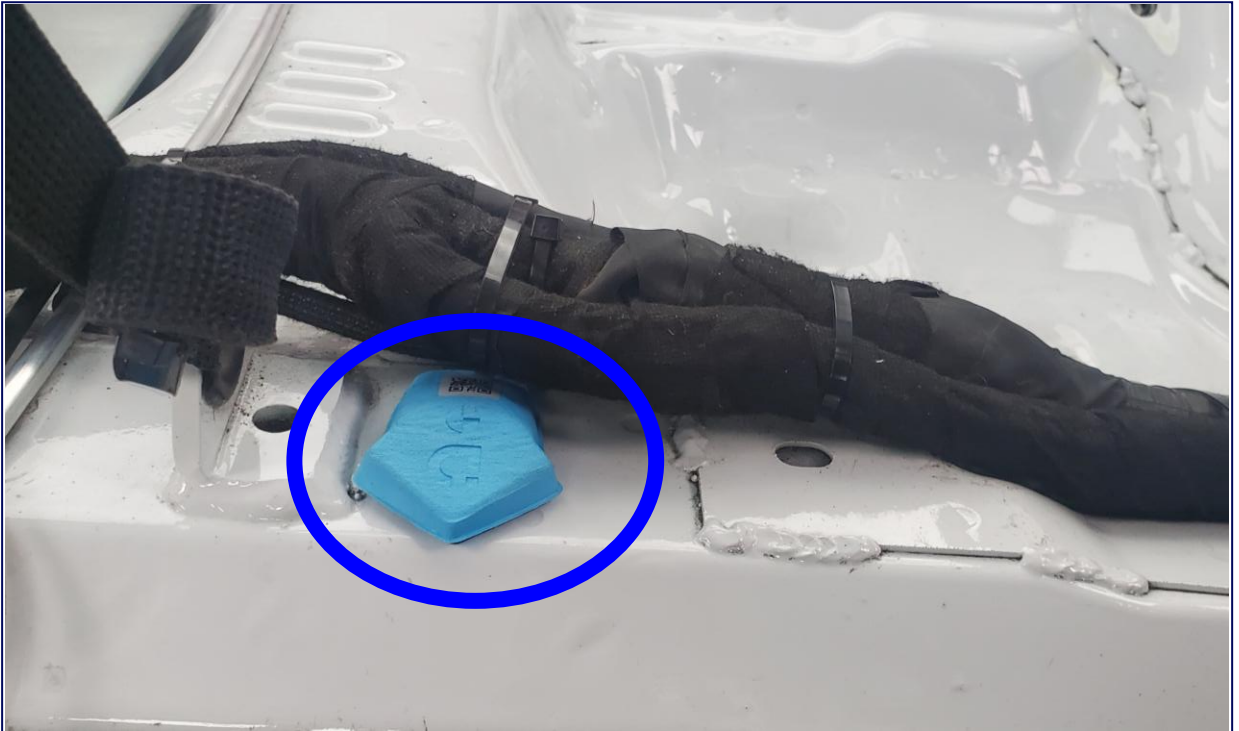

Incident Data Recorder Location
Rear Seat "Shelf" on Centerline

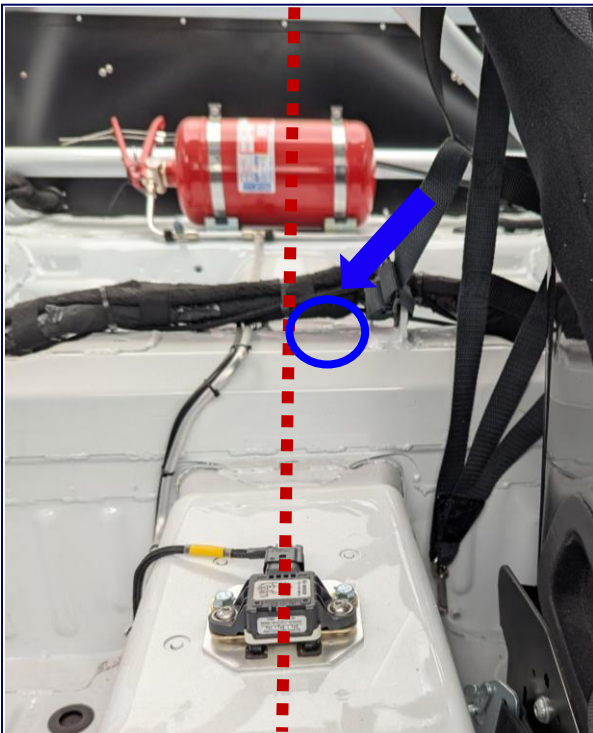

Incident Data Recorder Location 1
Place IDR to the left (towards passenger side) of the welded-on eyelet

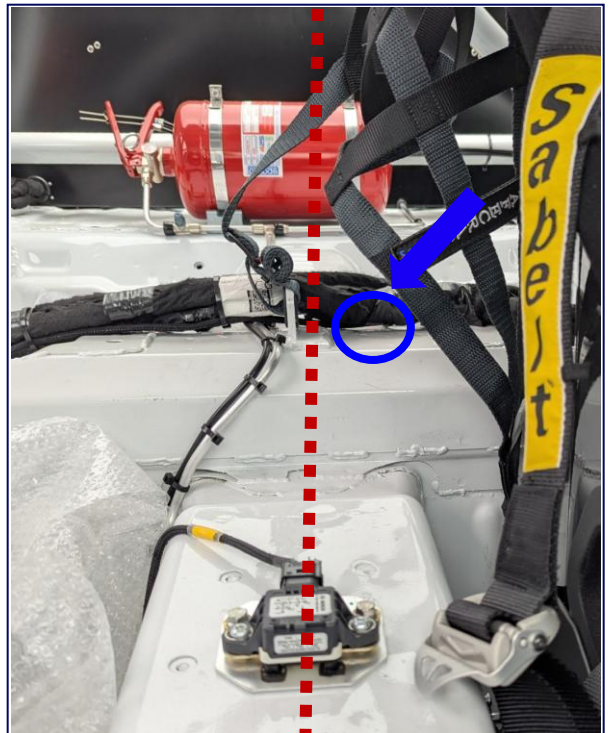

Incident Data Recorder Location 2
Place IDR to the right (towards driver side) of the welded-on eyelet

Camera System

Required – Mustang Cup USA & AU
Optional – Mustang Challenge NA



VBOX HD2 Camera System

Optional – Mustang Cup AU Only



AiM SmartyCam 3 Corsa

Camera System – Optional for Mustang Challenge NA VBOX Required for Mustang Cup USA



VBOX Mount Location Option 1
Passenger Side Roll Cage



VBOX Mount Location Option 2
Passenger Side Waterfall

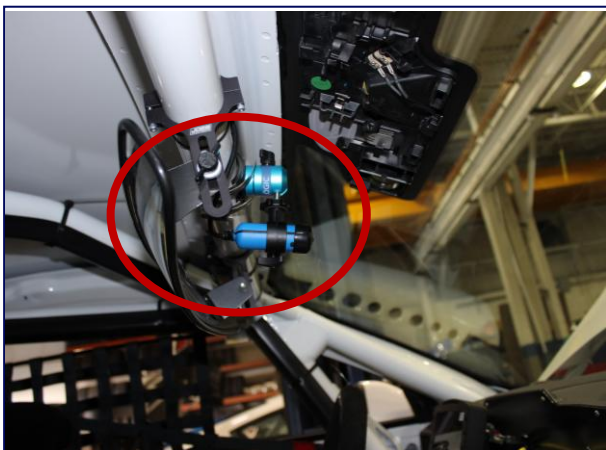

VBOX / GoPro Camera Location 1
Behind Rear View Mirror

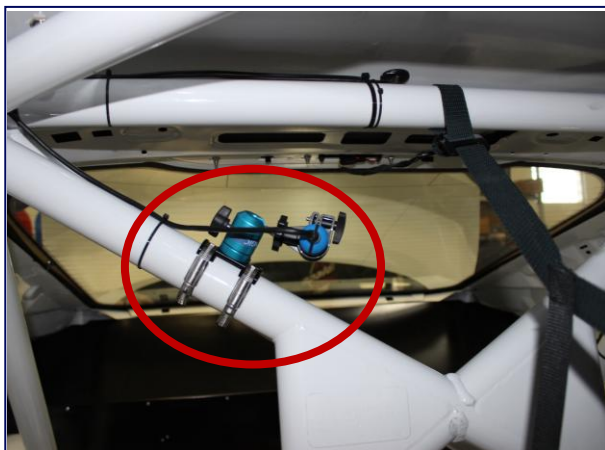

VBOX / GoPro Camera Location 2
Passenger Side Roll Cage

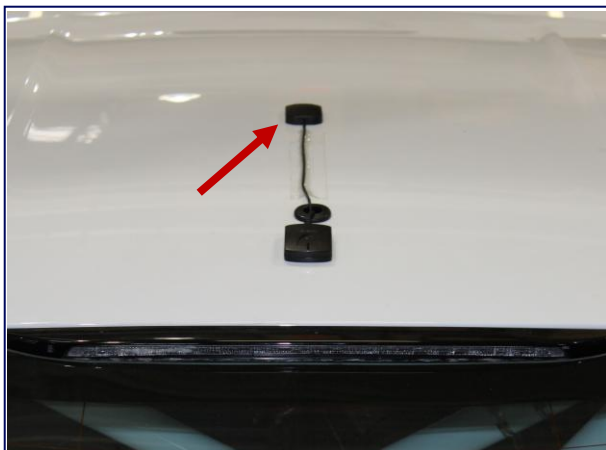

VBOX Antenna Location
Roof Center



VBOX Wiring Labeled "CAN4"
Underneath Dash

Camera System – Optional for Mustang Challenge NA VBOX Required for Mustang Cup USA

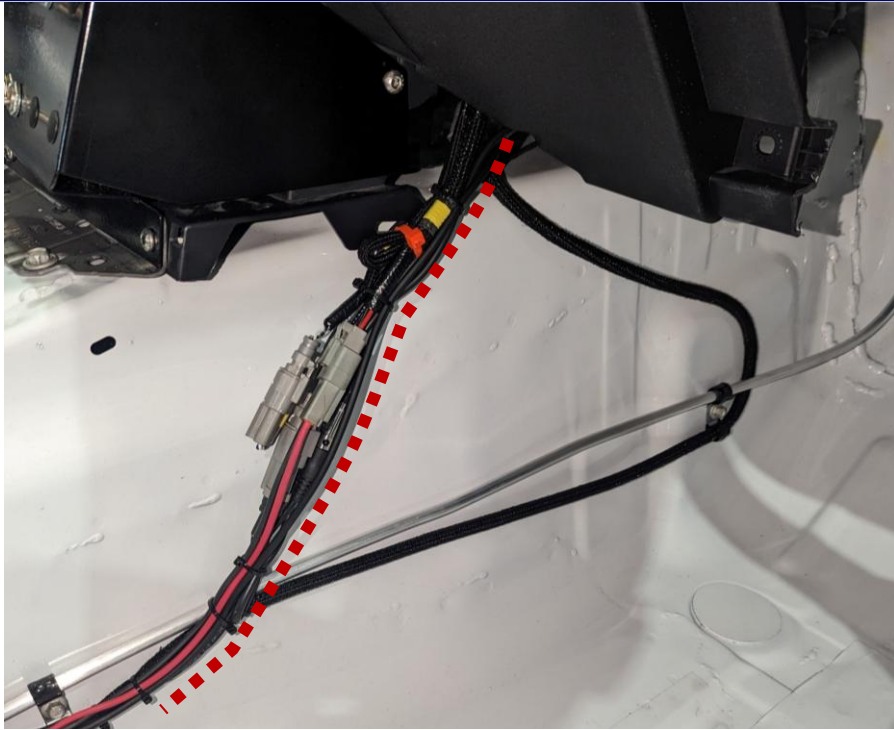

VBOX Harness Routing (Red Dotted Line)

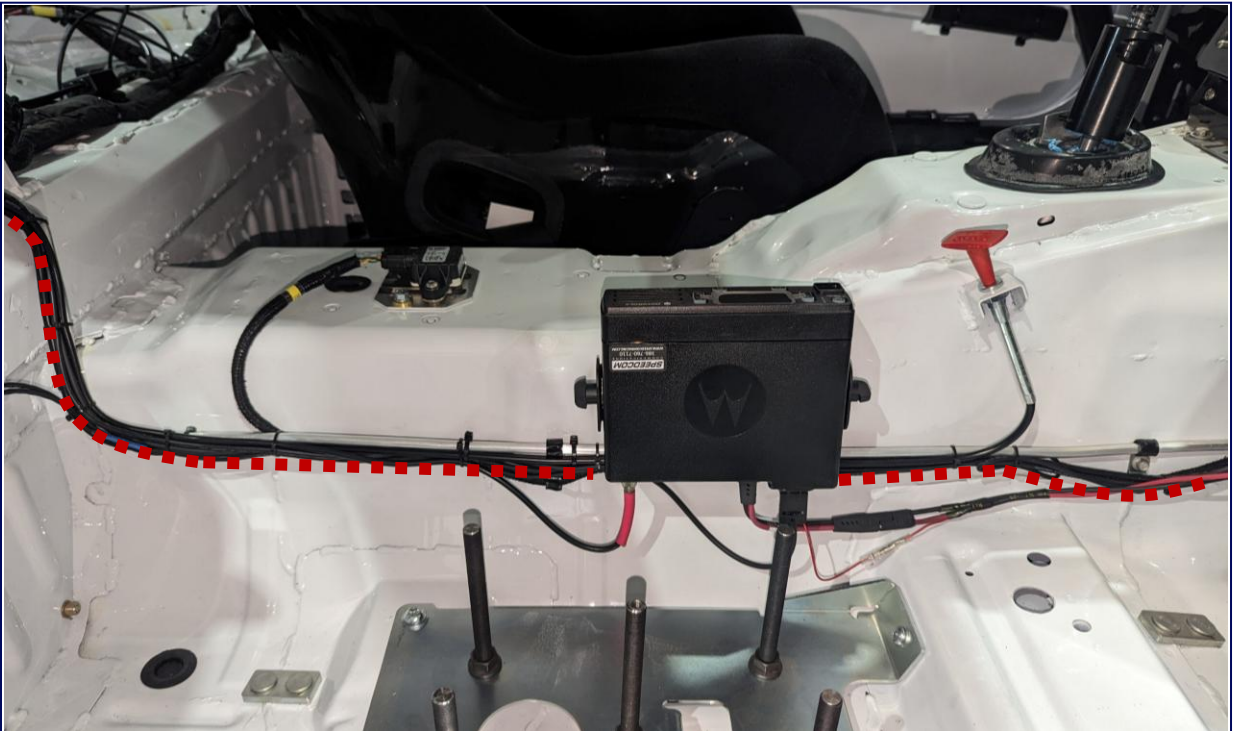

VBOX Harness Routing (Red Dotted Line)

Driver Cooling System – Optional



Driver Cooling System Location
Passenger Side Footwell

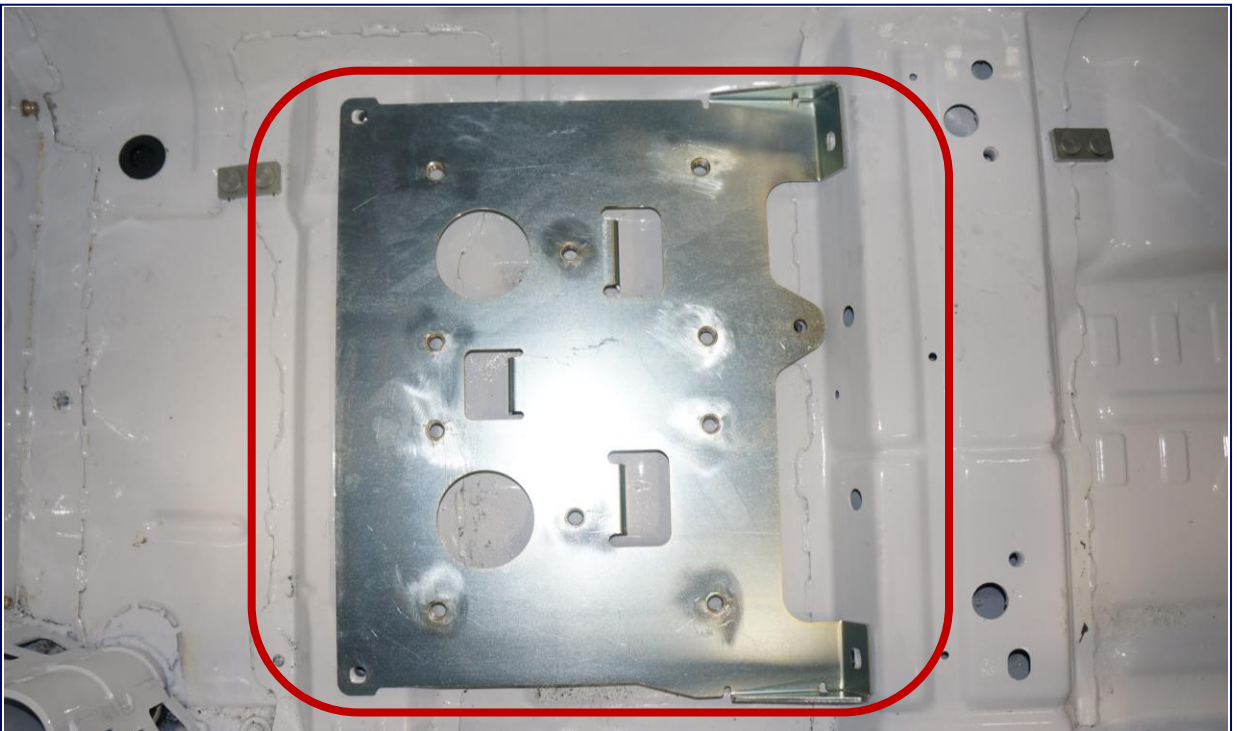

Alternate Driver Cooling System Mount Location – Passenger Side

Customers can use the Ballast Mount plate to mount a Driver Cooling System, or the plate can be removed to use an alternate mounting method – ONLY if Ballast is not required

Driver Cooling System Mount

Optional



Rear Driver Cooling System Mount,
Passenger Side*
FR-63160-B
*Mount will be zinc-plated



Driver Cooling System Mount, Passenger
Side Location
FR-63160-B

Optional – Mustang Cup USA Only



Rear Driver Cooling System Mount –
Driver's Side
FR-63160-A



Driver Cooling System Mount, Driver's
Side Location
FR-63160-A

Ride Height / Splitter Height Reference Points

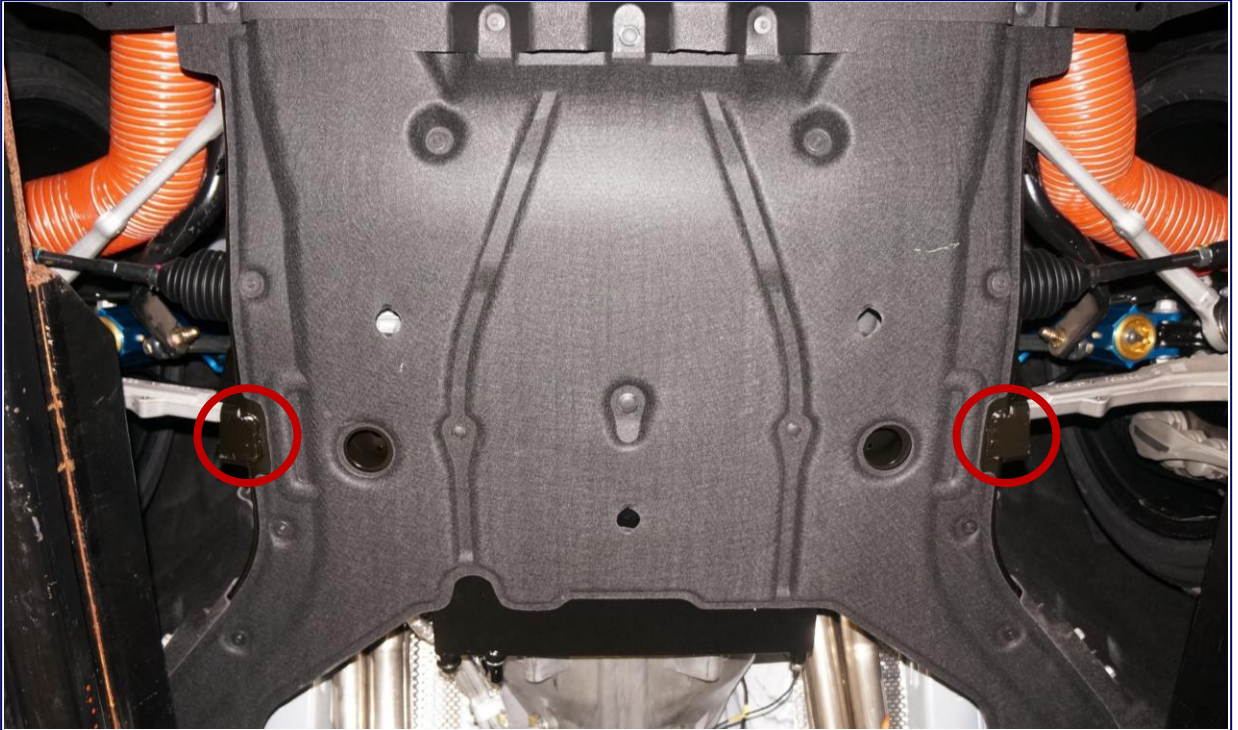

Front Ride Height Reference Points

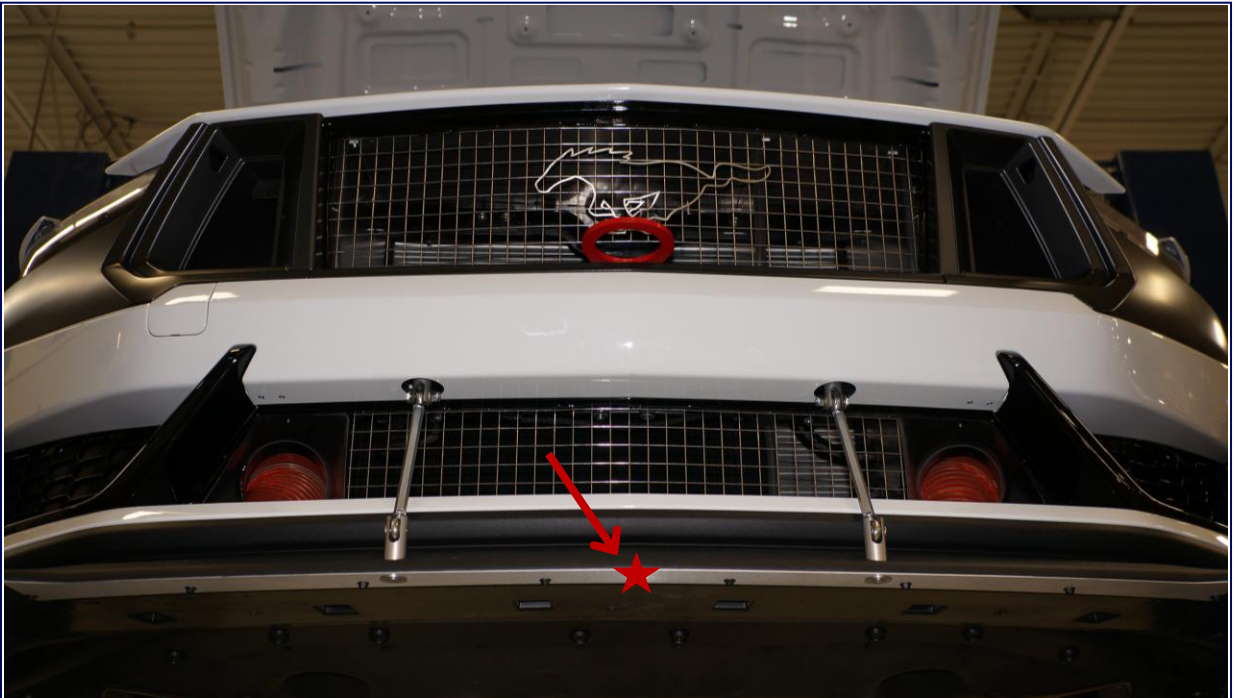

Splitter Height Reference Point
From the center of the aluminum Splitter Support surface (marked in red) to the ground

Front/Rear Fascia Mount Repair



Front Fascia Mount Repair
Only repair allowed for damaged front fascia corner mounts



Rear Fascia Mount Repair
Only repair allowed for damaged rear fascia corner mounts

Engine Service Pigtails



Fuel Injector (Port)
5U2Z-14S411-ZB



Variable Camshaft Timing (VCT) Solenoid
AU2Z-14S411-DB



APP
9U2Z-14S411-BC



Fuel Rail Pressure (Direct)
CU2Z-14S411-AVB



Throttle Position (TP)
AU2Z-14S411-MA



CPP Travel
CU2Z-14S411-AGB



AAT
AU2Z-14S411-AGC



PEM
DU2Z-14S411-CB

Engine Service Pigtails



HP Fuel Pump
EU2Z-14S411-MB



Engine Oil Pressure (EOP)
HU2Z-14S411-BA



CHT
GU2Z-14S411-KA



Intake Manifold Runner Controller (IMRC) Position
HU2Z-14S411-BA



Cam Shaft Position
HU2Z-14S411-BA



Knock Sensor
JU2Z-14S411-TA



Crankshaft Position
HU2Z-14S411-BA



Fuel Rail Pressure/Temp (Port)
JU2Z-14S411-CA

Engine Service Pigtails



MAF/IAT
JU2Z-14S411-ACA



Fuel Injector (Direct) Harness BNK 1 – RH
MU5Z-14A411-LA



MAP
JU2Z-14S411-ACA



Fuel Injector (Direct) Harness BNK 2 – LH
MU5Z-14A411-MA



Ignition Coil
KU2Z-14S411-BA



Cooling Fan Relay Holder
LU2Z-14S411-GA

Change Log

Version #	Date	Summary of Changes
1.0	2.19.2026	-
2.1	6.3.2026	<ul style="list-style-type: none"> • Added Hood Pin Reinforcement Kit (pg. 17) • Added optional Shifter (pg. 45) • Changed part number for Transmission Oil Cooler Line to FR-7R081-DHR (pg. 48) • Changed part number for Transmission Oil Cooler Tube Assembly to FR-7R081-DHR (pg. 48) • Updated Battery Hold Down Kit to Optional for Mustang Cup USA & AU (pg. 58) • Updated Recommended Fluids (pg. 71) • Updated ToC and version #