

FORD

PERFORMANCE

Dark Horse R Owner's Manual

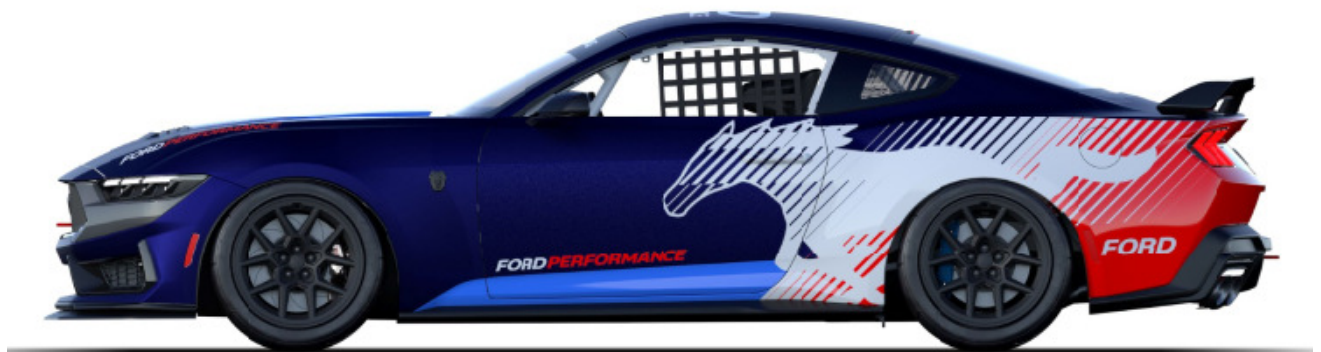



FORD PERFORMANCE

2024 Mustang Dark Horse R

Table of Contents

1.0 INTRODUCTION	Page 3
2.0 VEHICLE SPECIFICATIONS	Page 4
3.0 START-UP PROCEDURE	Page 6
4.0 MOTEC DATA SYSTEM	Page 7
5.0 DRIVER CONTROLS & PROCAL	Page 19
6.0 ELECTRICAL SYSTEMS	Page 33
7.0 ENGINE	Page 36
8.0 DRIVETRAIN	Page 41
9.0 FUEL SYSTEM	Page 47
10.0 CHASSIS SYSTEM	Page 49
11.0 SETUP AND RECOMMENDATIONS	Page 60
12.0 KEY CONTACTS	Page 62



2024 Mustang Dark Horse R

1.0 INTRODUCTION

ATTENTION!

This vehicle is for off-road use **ONLY** and is **NOT** street legal.
Before operating your Ford Performance Dark Horse R, please read and understand this operation manual!

The Dark Horse R is a production based, purpose-built track car that requires proper race preparation and maintenance. Prior to usage, "nut and bolt" your Dark Horse R. See the vehicle Build of Materials (BOM) for all torque specifications. This is a process of checking all the nuts, bolts, wiring, belts, hoses, tires, etc. on your vehicle. I.E., check your tire pressures, as they will change over time and need to be checked before every run. Beyond component specific maintenance, we recommend you regularly perform a "nut and bolt" inspection.

To maintain competition legality and avoid disqualification, follow the tuning practices and rules as listed where applicable in this manual and in the Dark Horse R Series Technical regulations.

It is the user's responsibility to equip themselves with the proper safety gear, including but not limited to a helmet, balaclava, HANS device, fire suit, gloves, fire shoes, fire-rated undergarments, and other applicable safety gear.

Be diligent with the care and maintenance of your vehicle!

ATTENTION!

It is the sole responsibility of the driver to ensure they fit safely in the vehicle. This includes but is not limited to the adjustment of the steering column, seat position, and seatbelt adjustment, as well as proper padding of appropriate roll bars that the driver may encounter. Fire pin must be pulled before using vehicle.



FORD PERFORMANCE

2024 Mustang Dark Horse R

2.0 VEHICLE SPECIFICATION

Engine

5.0-liter four-valve-per-cylinder V8 engine prepared by Ford Performance
Unique Ford Performance engine calibration
Upgraded engine oil cooling system
Race headers and custom exhaust system
Firing order: 1-5-4-8-6-3-7-2
Right bank 1-2-3-4
Left bank 5-6-7-8

Driveline

Six speed Tremec manual transmission
Upgraded transmission oil cooler with integral oil pump
Torsen rear differential with upgraded differential pump and coolers
3.73 final drive ratio

Chassis

Seam welded unibody chassis
Motorsport UK certified safety cage, FIA compliant
Front: Multimatic DSSV 2-way adjustable dampers
Adjustable camber plates
Rear: Multimatic DSSV 2-way adjustable dampers
Adjustable front and rear anti-roll bar drop links
Race EPAS (Electronic Power Assist Steering)

Electrical

Ford Production/Ford Performance wiring harnesses
Motec C187 data collection system with GPS
Center console switch plate
Master power in two locations

Interior

Recaro Pro Racer XL SPG racing seat and slider
Sparco fire suppression system
Sparco/Ford Performance quick release steering wheel
Safecraft Racing driver safety nets
Driver side-impact energy absorption foam
Sabelt 6-point racing harness

Exterior

Flush-mount hood pins
19x10.5 front and 19x11 rear wheels with production tires for transportation
Front/Rear tow hooks



FORD PERFORMANCE

2024 Mustang Dark Horse R

Brakes

Brembo 6 piston fixed front calipers
2-piece floating 390mm x 35mm front key drive rotors
Brembo front racing brake pads
Front brake cooling ducts
Brembo production rear calipers
1-piece 355mm x 28mm rear brake rotors
Brembo rear racing brake pads
Stainless steel braided brake hoses
Bosch custom calibrated racing ABS system

3.0 START-UP PROCEDURE

Pre-Start Up

Ensure the engine is filled with all required fluids to the recommended levels. Ensure there is fuel in the vehicle.

ATTENTION!

Dark Horse R is compatible with pump unleaded premium fuel. It is recommended that VP Racing E10 is used. Use of other fuels is not recommended and can cause serious damage to your engine!

Start-Up Procedure

1. Turn on the electrical system by switching “ON” the master power switch, see figure 3.1. Note: verify that the external master switch is also “ON”, see figure 3.2. It is located on the cowl in the lower, driver’s side corner below the windshield.
2. Turn on the ignition system by switching “ON” the ignition switch, see figure 3.1.
3. Depress the clutch. The car WILL NOT START if the clutch is not depressed. It is recommended that the car be put into neutral.
4. Depress START/STOP button, see figure 3.1. The vehicle is equipped with auto-start, and holding the START button is not required.

Shutdown Procedure

1. Allow the car to idle for a few seconds to stabilize all readings.
2. Shut off ignition switch.
3. Turn off master power switch.



Figure 3.1



Figure 3.2

4.0 MoTeC DATA SYSTEM

4.1 MoTeC OVERVIEW

This vehicle is equipped with a MoTeC C187 dash display. The dash is responsible for displaying vital information to the driver/user and logging data while on track. The unit features three default mode screens: 'Race', 'Vitals' and a diagnostic trouble code (DTC) screen. Each screen is intended to provide the driver/user with the necessary information while warming up, driving, and during maintenance. Each screen can be further customized to fit each driver's preferences using C187 dash manager software in conjunction with MoTeC's Display Creator. The different screens are explained in section 4.4 of this manual.

4.2 MoTeC DASH MANAGER

Your MoTeC dash is accessible through the MoTeC C187 Dash Manager application. This is an application available for download at <https://www.motec.com.au/products/C187>. Installation support of the C187 dash manager software is available through the MoTeC website. With this software you can change screen settings, logging settings, and shift light configurations, as well as retrieve logged data from the device.

Downloading the configuration from the dash can be done with the MoTeC C187 Dash Manager following these steps:

1. Open the C187 Dash Manager
2. Connect the computer to the data port (ethernet) located in the glove box area.
3. Select Online -> Get Configuration as shown in Figure 4.21.

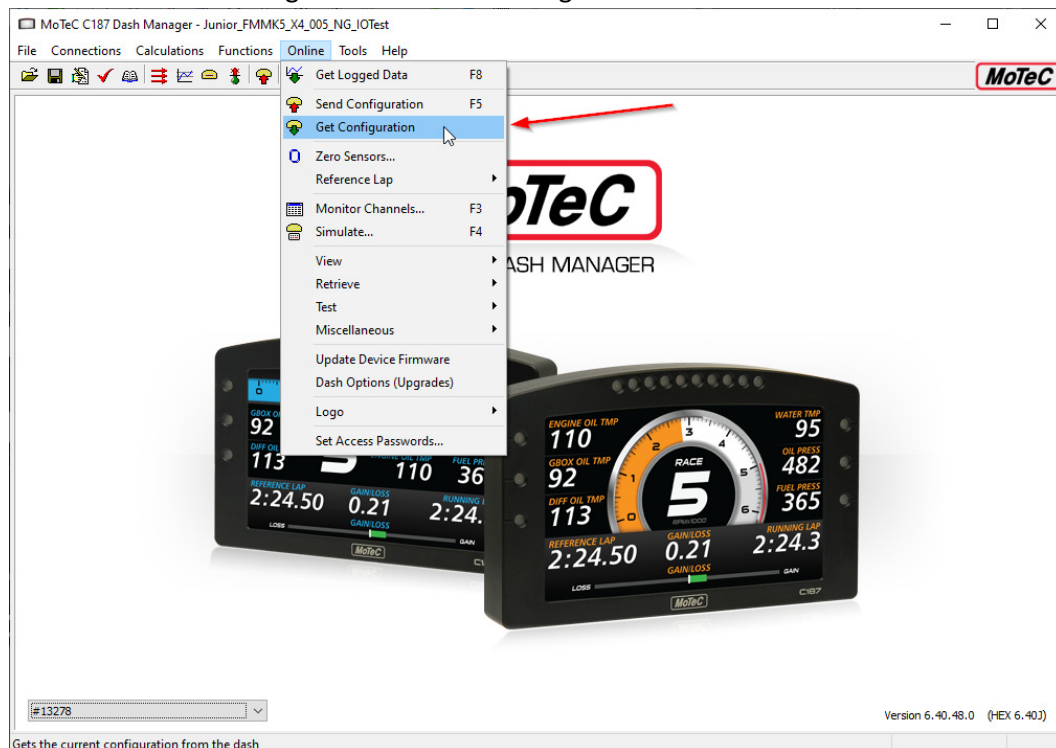

Figure 4.21: MoTeC Dash Manager – retrieving the current configuration.

2024 Mustang Dark Horse R

If changes are made to the C187 dash config, it can be re-saved and uploaded to the dash in the same fashion that it was retrieved from it. In this case, the 'Send Configuration' will be used to upload the new version of the dash config. This will need to be done in the case that an updated version of the dash config is released.

To upload a new dash config to the device, follow these steps:

1. Open the C187 Dash Manager
2. Connect the computer to the data port (ethernet) located in the glove box area.
3. Open the dash configuration you wish to send to the dash.
4. Select Online -> Send Configuration

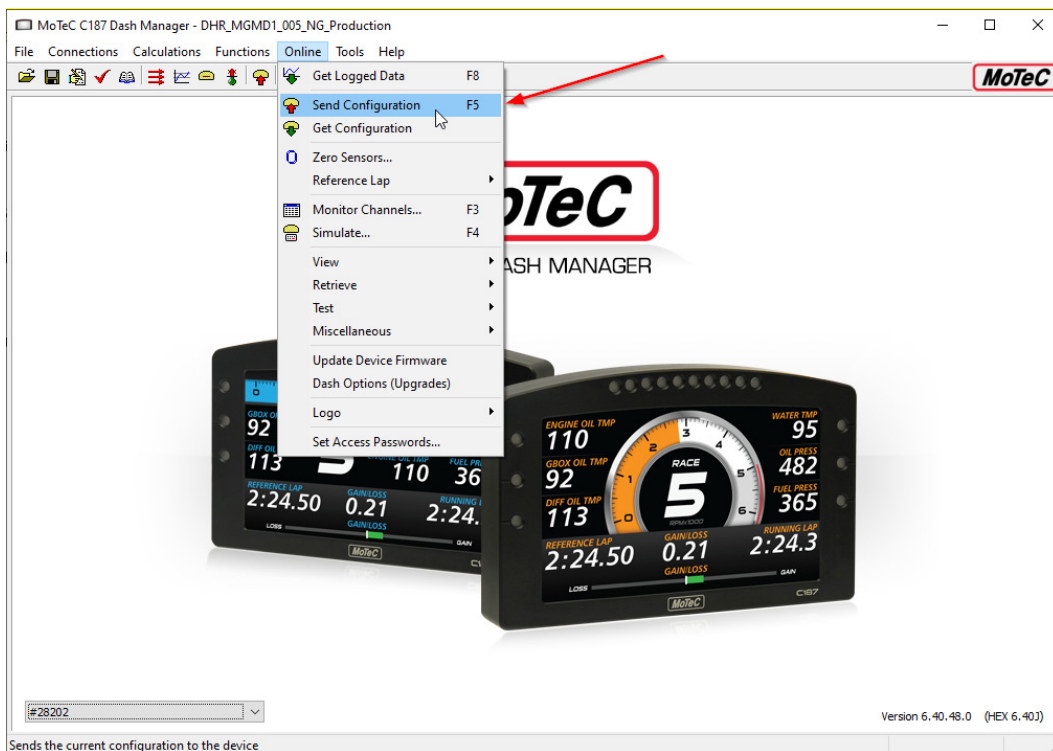

Figure 4.22: MoTeC Dash Manager – sending a new configuration.

It is also important to retrieve data off the device and label it properly because the dash has a finite amount of memory available before it will begin to overwrite older data files. Good practice would be to 'pull' data every stoppage of the vehicle to catalog and review data to ensure none is lost and it is recording as desired.

To retrieve data from the device, follow these steps:

1. Open the C187 Dash Manager
2. Connect the computer to the data port (ethernet) located in the glove box area.
3. Select Online -> Get Logged Data

2024 Mustang Dark Horse R

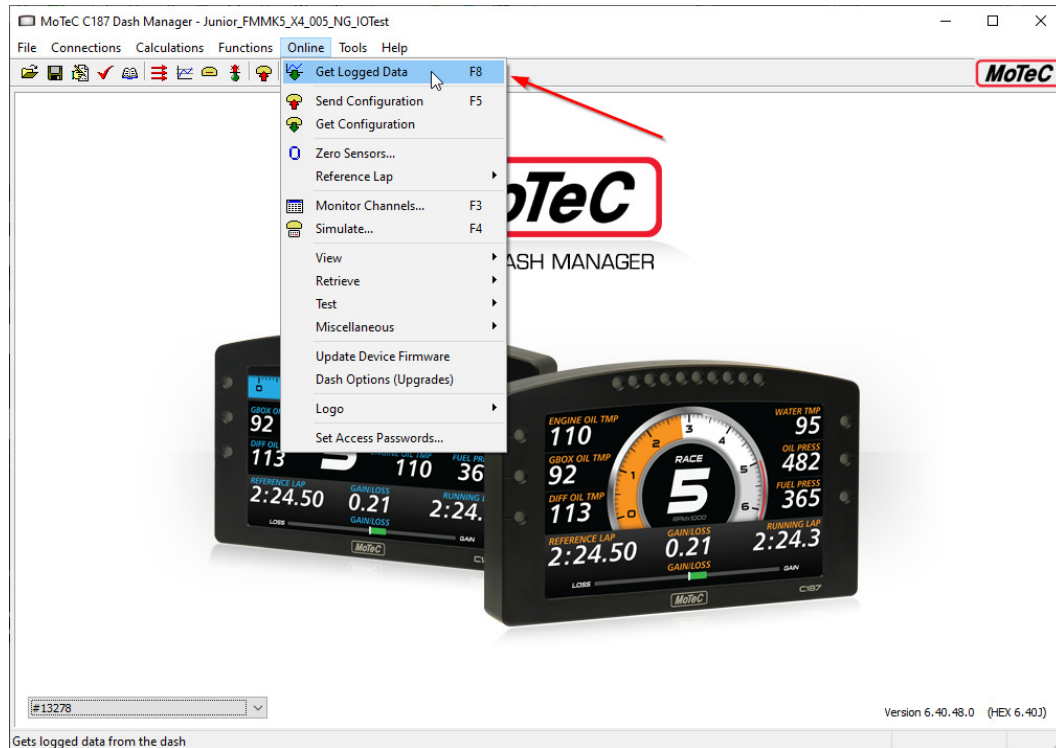
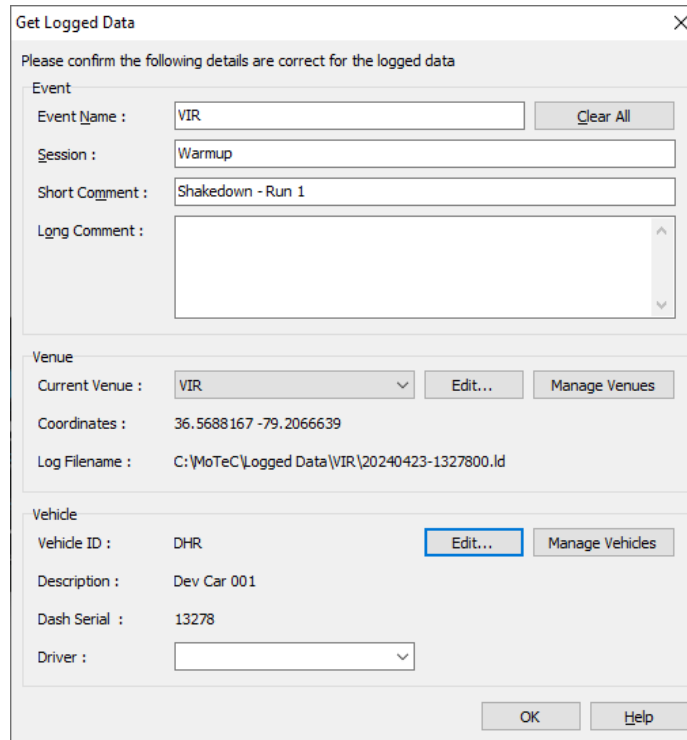

Figure 4.23: MoTeC Dash Manager – get logged data location.

4. Enter relevant outing information. Your Dark Horse R comes with the vehicle information already entered and will be available in the vehicles tab after retrieving data the first time. Common North American venues are included on the dash configuration and will be available in the venues after retrieving the data the first time.

2024 Mustang Dark Horse R



Get Logged Data

Please confirm the following details are correct for the logged data

Event

Event Name : VIR

Session : Warmup

Short Comment : Shakedown - Run 1

Long Comment :

Venue

Current Venue : VIR

Coordinates : 36.5688 167 -79.2066639

Log Filename : C:\MoTeC\Logged Data\VIR\20240423-1327800.Id

Vehicle

Vehicle ID : DHR

Description : Dev Car 001

Dash Serial : 13278

Driver :

Figure 4.24: MoTeC Dash Manager – get logged data screen.

5. By default, MoTeC will save data to C:\Users\%username%\Documents\MoTeC\Logged Data\, where ‘%username’ is the unique username for that user of the computer.

4.3 MoTeC DATA ANALYSIS– i2

Data recorded on your MoTeC C187 and downloaded through MoTeC dash manager is read through the MoTeC i2 Standard program. From the factory, the dash will generate i2 standard files, not i2 Pro files. MoTeC i2 Standard is available for download at <https://www.motec.com.au/products/C187> near the bottom of the page. Installation instructions and additional help is available on the MoTeC website. Additional advanced tutorials and data analysis strategies not covered in this manual are also available on the MoTeC website. Below is a quick introduction to the MoTeC i2 software.

1. After installation, launch the MoTeC i2 Standard software.
2. Here you will be greeted with a screen to select a workspace. i2 Standard allows for 4 default workspaces to suit various needs. It is recommended to use the circuit workspace as a starting point. Each workspace is adjustable to an individual’s preferences.

2024 Mustang Dark Horse R

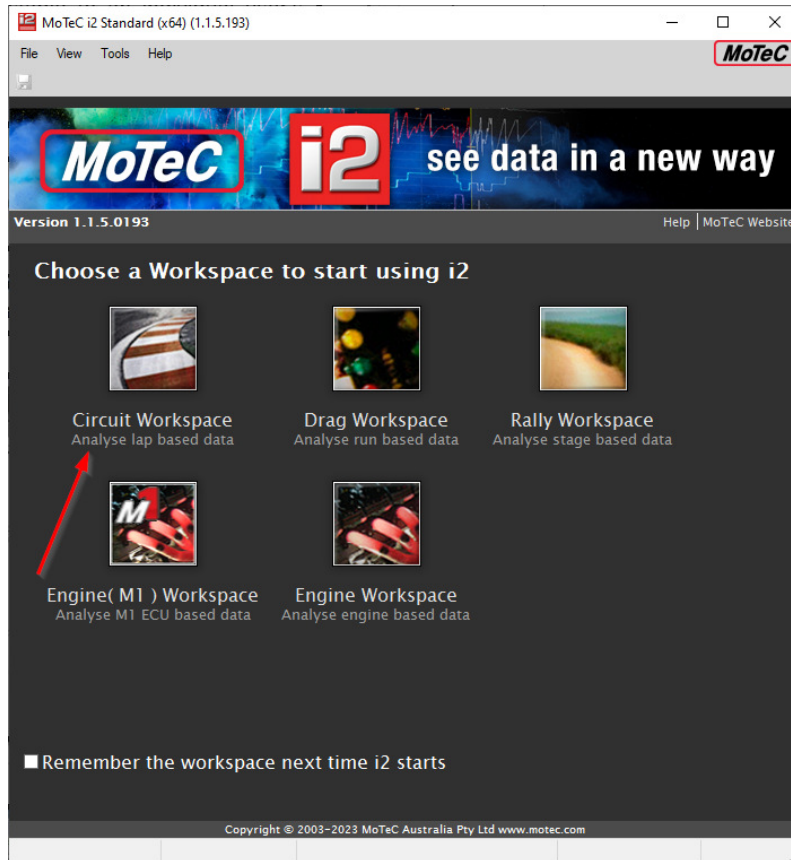

Figure 4.31: MoTeC i2 – standard launch screen.



Figure 4.32: MoTeC i2 – new data analysis screen upon selecting 'Circuit Workspace'.

2024 Mustang Dark Horse R

- Open a file by selecting the open icon in the top left corner, also found under File -> Open Log File...

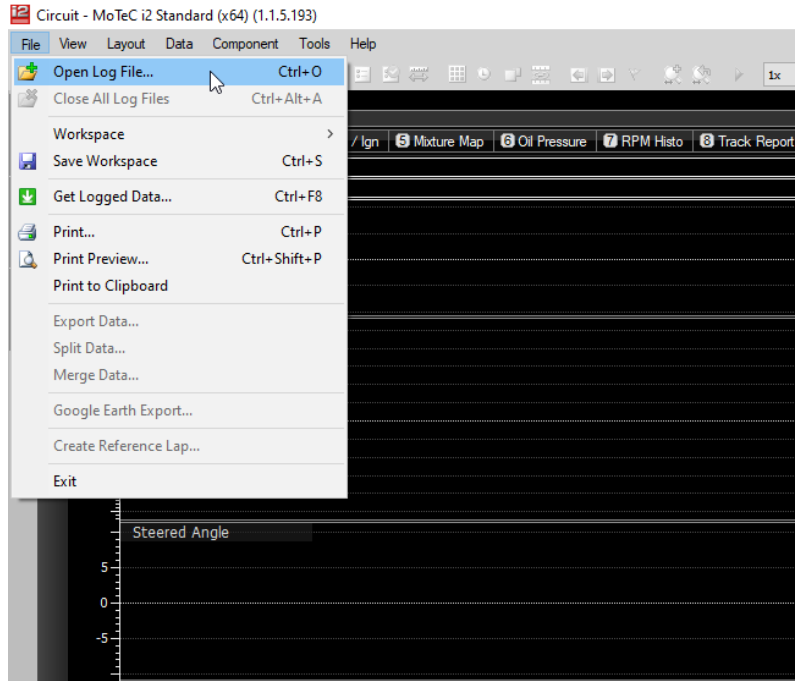

Figure 4.33: MoTeC i2 – opening a log file within i2 workspace.

- At this point, i2 will list each individual file, along with any notes taken at the time the data was saved. Shown below is a data file from the default MoTeC configuration.

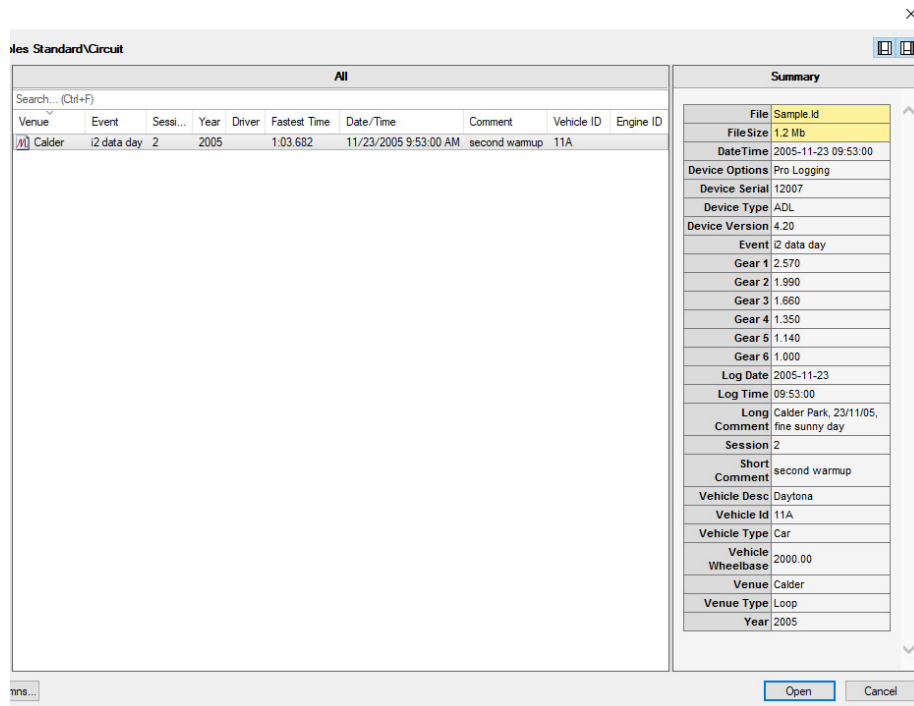

Figure 4.34: MoTeC i2 – example configuration for a logged file in MoTeC i2.



FORD PERFORMANCE

2024 Mustang Dark Horse R

5. Click 'Open' at the bottom of the window and data will populate the graphs/plots in the i2 workspace.
6. To add channels viewed, click CHANNELS on the left side. Additionally, the groups of channels can be modified by right clicking and selecting properties or pressing F5. Groups can only be modified when a file is opened. For additional help with MoTeC i2, consult MoTeC help documentation available on the MoTeC website.

4.4 MoTeC DISPLAY CREATOR

Under the original configuration, your vehicle is supplied with three screen modes. An additional feature of the dash is a license that allows the user to create unique screens with additional functionality over the default screen options. The design of those screens is possible with the help of MoTeC's Display Creator. It is available for download at <https://www.motec.com.au/products/C187>.

1. After installation, launch the Display Creator software.
2. You will be prompted to choose either a new or existing project.
3. It is recommended that you exit this window.

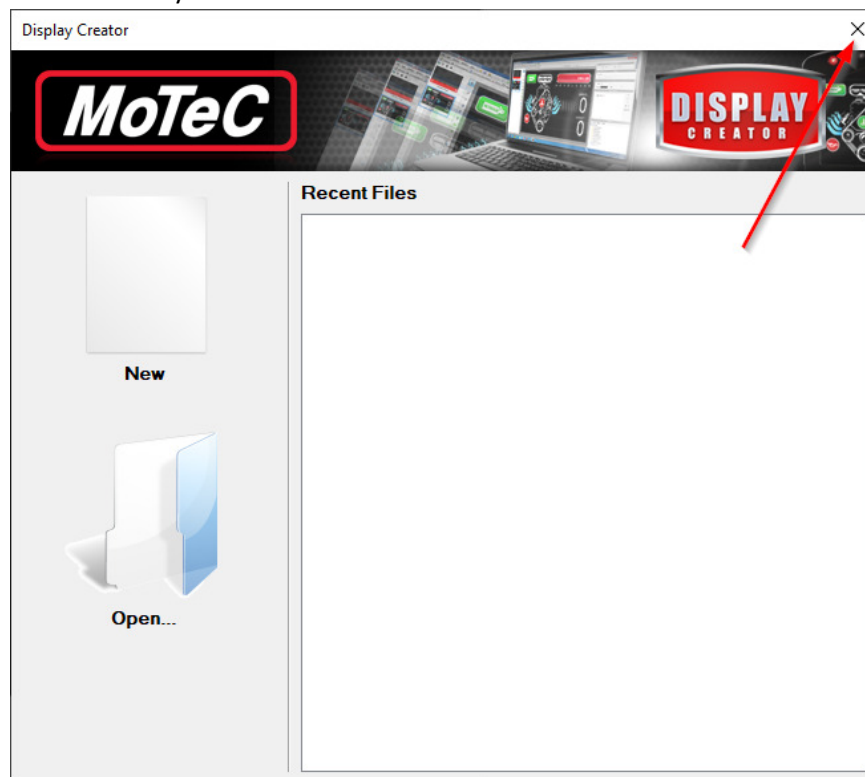

Figure 4.41: Display Creator – project selection window.

4. From here select Device -> Configure Device... and a new window will appear.
5. Now you will want to retrieve the existing Display Creator project from the dash by selecting 'Get Project' as shown in Figure 4.42.
6. It is important the original project is saved to your computer because once a new project is sent to the dash the original project is replaced and cannot be recovered.

2024 Mustang Dark Horse R

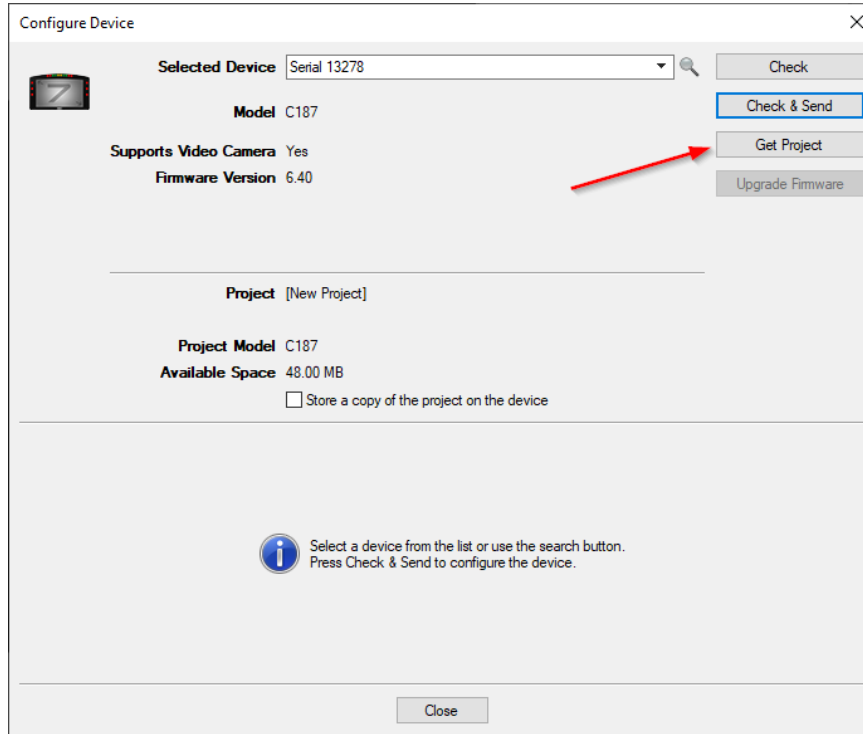

Figure 4.42: Display Creator – downloading a project from the dash.

7. Now you can edit the display creator project.

When changes are made to the dash configuration within the Motec Dash Manager, a new .dbc file is generated when those changes are saved. This new .dbc file can be found in the same location as the configuration file.

Attention: A situation that may occur when a new configuration is sent to the dash (as defined in section 4.2) is a conflict between the configuration and the display creator project. Follow the steps outlined below to resolve this issue.

To avoid any errors when sending the new configuration to the dash follow these steps:

1. Open Display Creator
2. Navigate to the communications tab as shown in Figure 4.43.

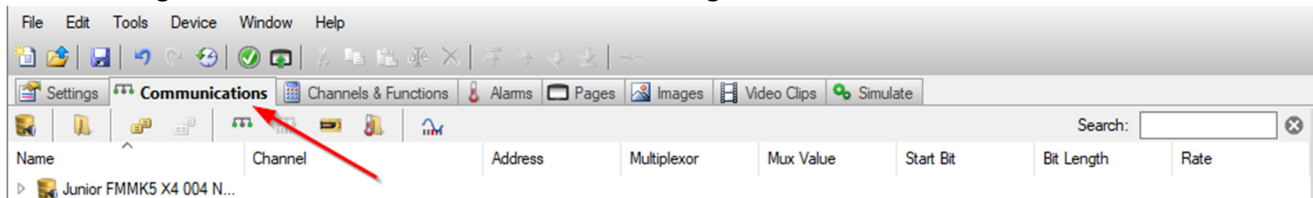

Figure 4.43: Display Creator – communications tab.

3. Select the .dbc file in the communications tab and then hit the 'Select' button as shown in Figure 4.44.

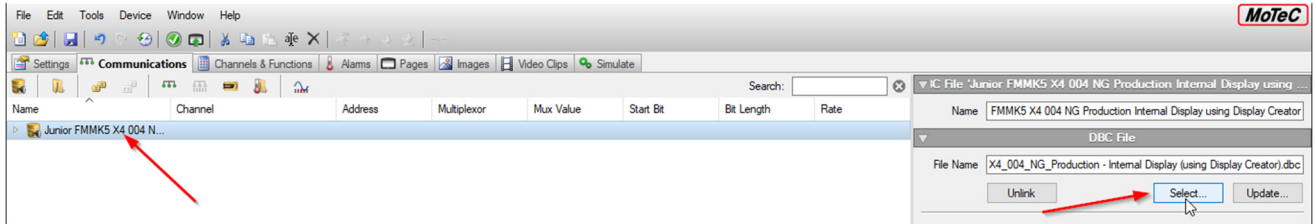

Figure 4.44: Display Creator – replacing an existing .dbc file.

4. Select the updated .dbc file and select 'OK' to the pop up that appears after selecting the new .dbc file. It may take few minutes for the old .dbc file to be replaced by the updated file.
5. This should help prevent any conflicts between the Dash Manager configuration and the Display Creator project. For additional help with Motec Display Creator, consult Motec help documentation available on the Motec website.

4.5 DATA SCREENS AND INDICATOR LIGHTS

From the factory, your Dark Horse R includes three screen modes. Each screen has a specific use case and can further be customized to a racer's preference. In this section each screen will be covered, along with its intended use case.

Within each screen is a center display which contains the same elements as shown in Figure 4.51.

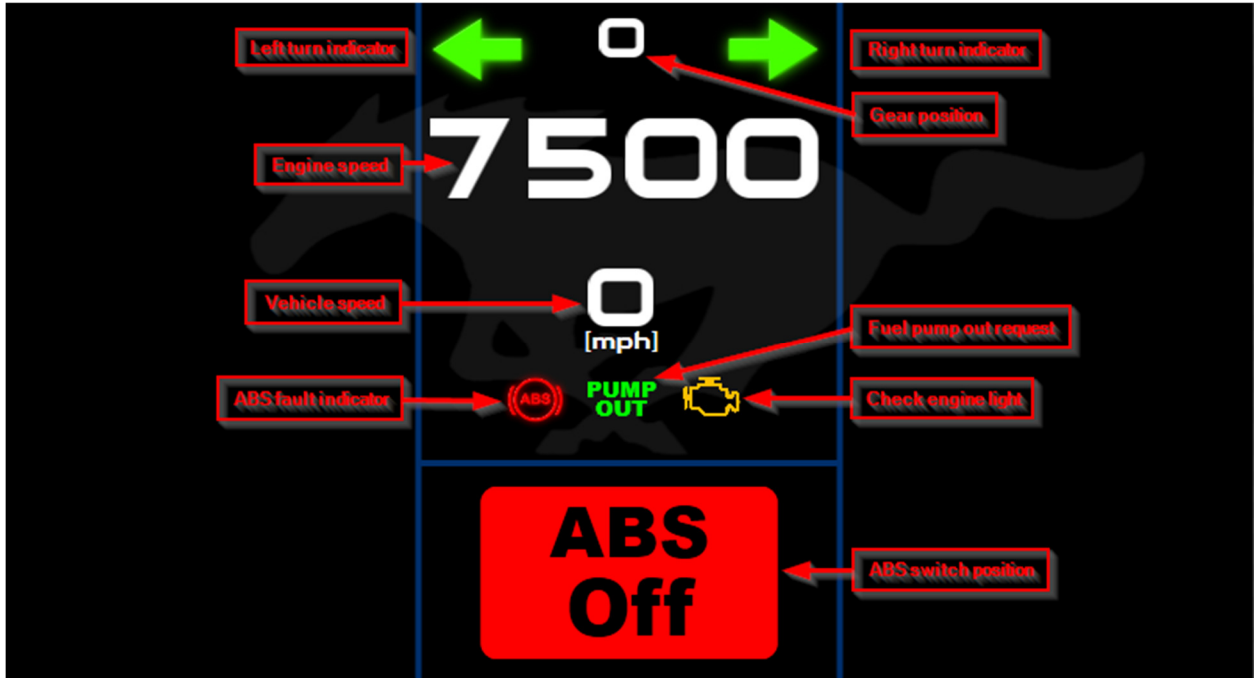

Figure 4.51: Common center display indicators.

Figure 4.52 is the 'Race' screen. This screen mode is the default screen upon power up of the vehicle. The purpose of this screen is to communicate fuel and track time information with critical temperature and pressure values below.

2024 Mustang Dark Horse R

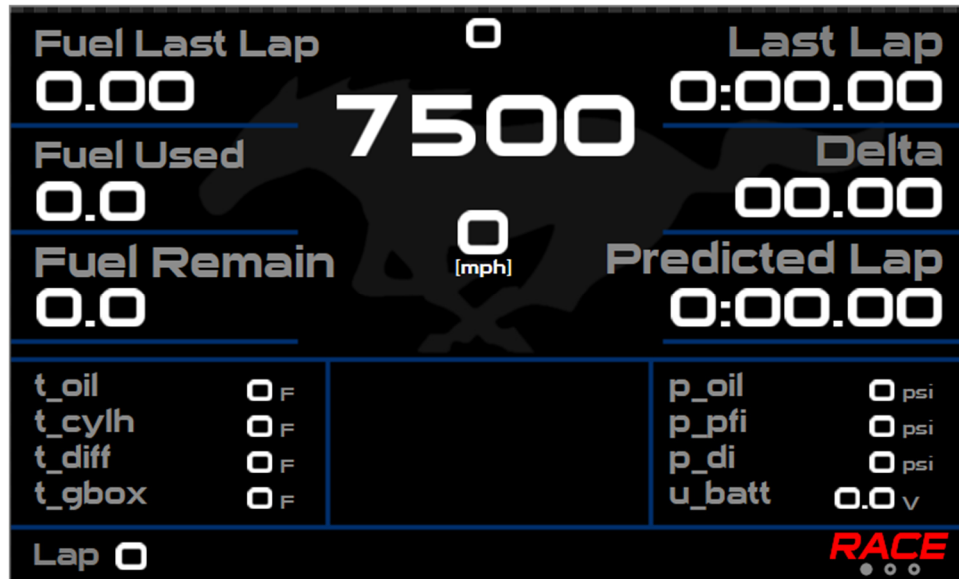

Figure 4.52: Motec dash – ‘Race’ screen.

It is important to note that the venue and track length need to be set for the ‘Fuel Last Lap’ and lap data to properly function.

Next is the Vitals screen. Shown in Figure 4.53, this screen gives a broader view of the car’s status compared to the Race screen. It is separated by system, each of which can be seen in yellow.

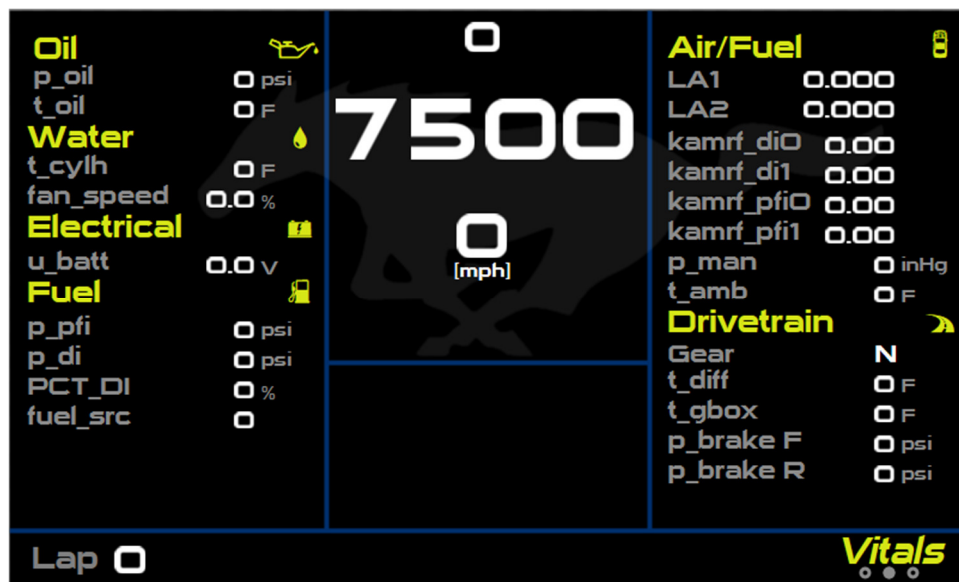

Figure 4.53: Motec dash – ‘Vitals’ screen.

On both the ‘Race’ and ‘Vitals’ screen the temperature and pressure values will change color to indicate to the driver/user the current state of the system. Shown in Figure 4.54 is an example of the different font colors.

2024 Mustang Dark Horse R

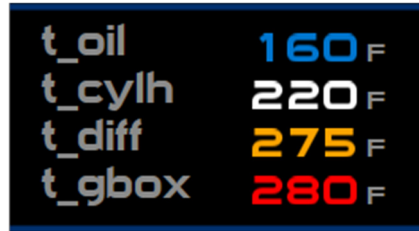

Figure 4.54: Motec dash – changing font color example.

Blue indicates the system is warming up. White indicates normal operation. Orange is to warn that a parameter is beginning to approach a critical value. Red is a critical value indicating that a system is operating outside of allowable limits and may cause damage if the vehicle continues to operate in that state.

Lastly is the 'DTC' screen. It will display any diagnostic trouble codes present on the vehicle as well as the status of the code.

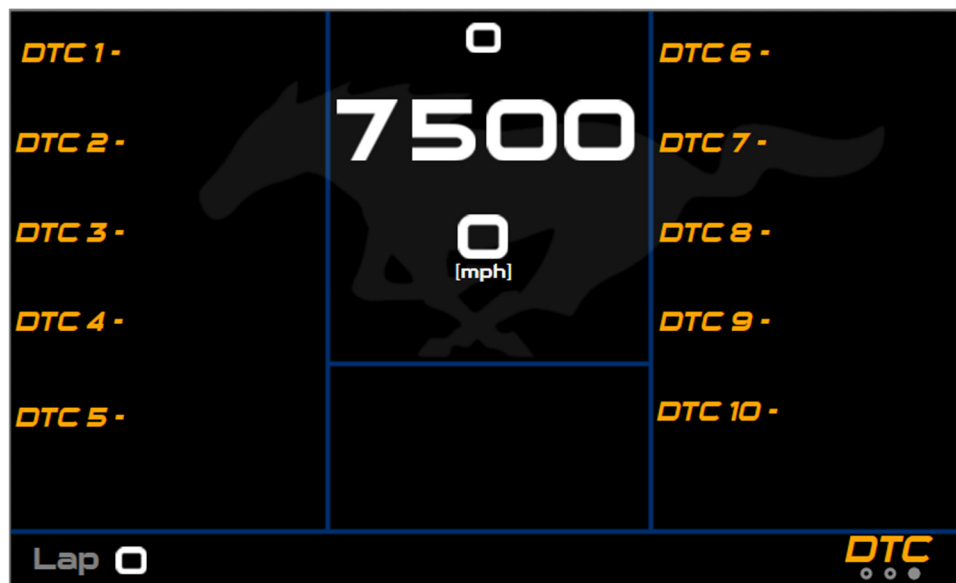

Figure 4.55: Motec dash – 'DTC' screen.

4.6 ADDITIONAL MoTeC NOTES

If a driver requests auxiliary shift lights, Motec will provide a kit with a shift light module that can be remotely mounted. The part number for the kit is #18120 and it simply needs a CAN connection and battery power to function. Refer to the Motec website for technical information specific to the kit.

The available CAN bus on the C187 dash is CAN 2. CAN2 LOW and CAN2 HI are pins 75 and 76, respectively, on the dash. Connect the shift light module to this CAN bus and follow these steps to configure the dash.

1. Begin by opening the Motec C187 Dash Manager.
2. Navigate to the 'Shift Light Module...' shown in Figure 4.61.

2024 Mustang Dark Horse R

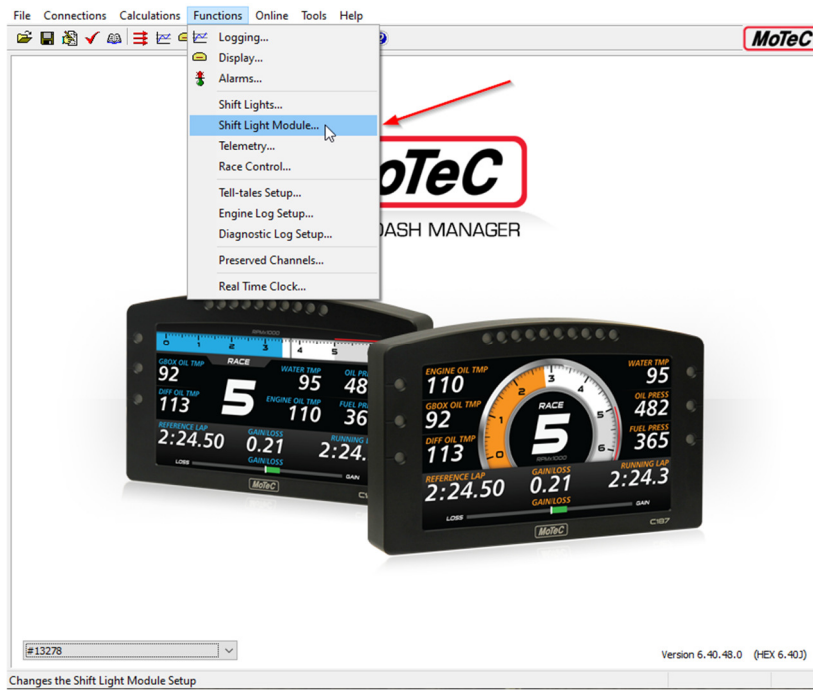

Figure 4.61: Motec Dash Manager – shift light module.

3. A pop up will appear and the following settings should be changed to match Figure 4.62.

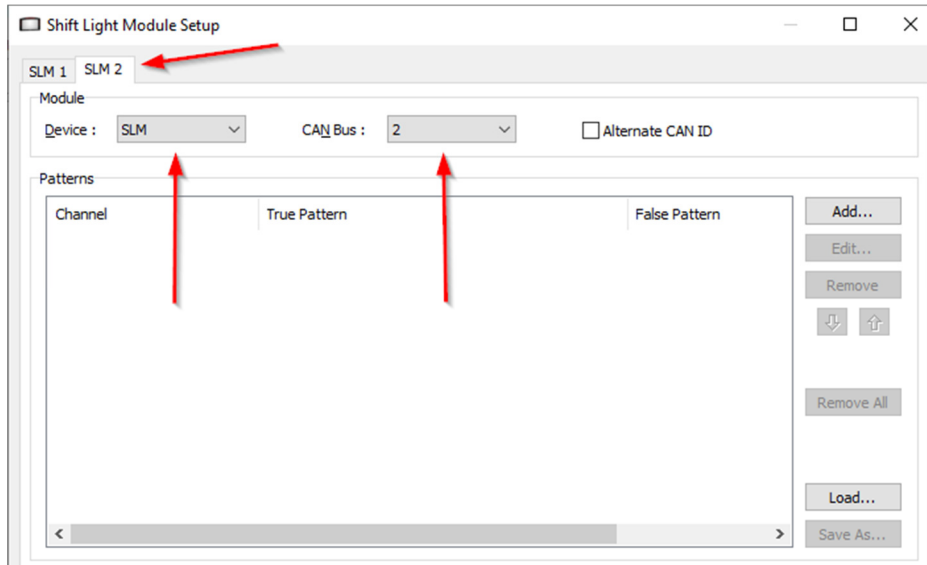

Figure 4.62: Motec Dash Manager – shift light module setup.

4. From here you can select the 'Add' button to create a shift light layout that matches the original dash shift light layout. For additional help with the Shift Light Module, consult Motec help documentation available on the Motec website.

2024 Mustang Dark Horse R

5.0 Driver Controls & ProCal



Switches

- Start/Stop Engine Button
 - Button to start engine crank and start sequence.
 - Not to be used for stopping engine
- Power switches: switch up for on and down for off.
 - Master Power: provides power to the vehicle.
 - Ignition: provides power to modules for ignition.
 - To be used for stopping engine



FORD PERFORMANCE

2024 Mustang Dark Horse R

- ABS Power: provides power to the ABS module.
- Rev Match: enables and disables auto rev match.
- Rain Lamp: turns rain lamp on and off.
- Spare 1: For team use
- Spare 2: For team use
- Overrides: switch up for on and down for auto.
 - Fuel: provides override power to fuel pump for draining fuel tank.
 - Diff: provides override power to differential pump during fluid changes.
- ABS Dial:
 - 12 Position dial for adjusting ABS aggressiveness.
- Mirror Dial:
 - Dial for adjusting side mirrors.
 - Rotate counterclockwise for left side mirror.
 - Rotate clockwise for right side mirror.
 - Move in direction that is desired for the mirror.



External Master Switch

- Right position is OFF.
- Left position is ON.

2024 Mustang Dark Horse R



Headlight Controls

- 4 Options: Off, DRL, Auto (default upon start), On
 - Off: Headlights are off.
 - DRL: Only daytime running lights are on.
 - Auto (default upon start): Headlights will turn on/off automatically dependent on light level.
 - On: Headlights are on.
- Rotate rotary knob to select headlight options.



Steering Wheel Function

- Radio Push to Talk
 - Press and hold "RADIO" button on steering wheel to talk on radio.
- Pit Speed Limiter
 - Press "PIT" button on steering wheel to turn on/off pit speed limiter.
 - All lights on dash will blink blue.
- Dash Mode Selector
 - Press "DASH MODE" button on steering wheel to cycle through three available display pages.
 - **Fuel Reset**, press and hold "DASH MODE" button for 8 seconds.
- Alarms
 - Press "Alarm" button on steering wheel to clear the alarms on the display.
 - Press and hold "Alarm" for 5 seconds on steering wheel to perform PCM (Powertrain Control Module) clear codes.

2024 Mustang Dark Horse R



Left Multi-Function Switch

- Blinker Control
 - Push “Down” on switch to activate left turn signal.
 - Push “Up” on switch to activate right turn signal.
- Headlight High-Beam Control
 - Pull “Towards” driver to momentarily activate high-beams.
 - Push “Away” from driver to turn on high-beams.
 - Pull back to “Neutral” position to turn off high-beams.





FORD PERFORMANCE

2024 Mustang Dark Horse R

Right Multi-Function Switch

- Windshield Wiper Control
 - Push “Down” to activate single wipe.
 - Push “Up” to first detent for intermittent wipe.
 - Use rotary knob to change the intermittent wipe interval.
 - 4 intervals available, fastest is up, slowest is down
 - Push “Up” to second detent for normal wipe.
 - Push “Up” to third detent for high-speed wipe.
 - NOTE: Washer system has been disconnected.



Display Screen

- Driver Pages – 3 Total Pages: RACE, Vitals, DTC
 - Select page by pressing the “Dash Mode” button on steering wheel.
 - Pages roll over after end.

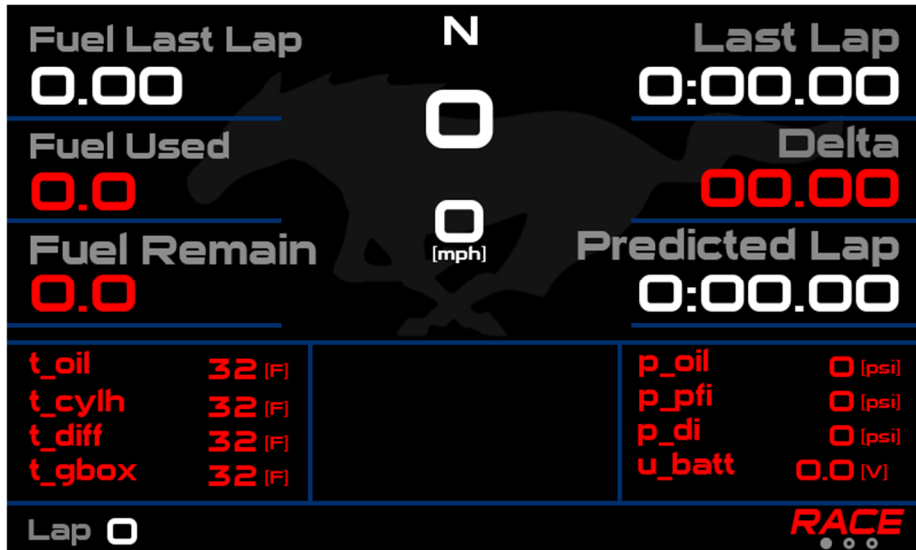

RACE



FORD PERFORMANCE

2024 Mustang Dark Horse R

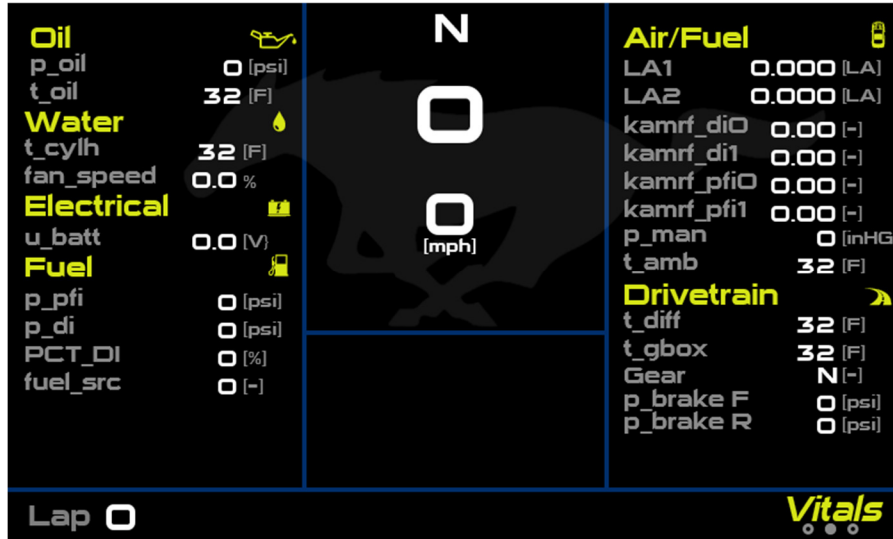

Vitals

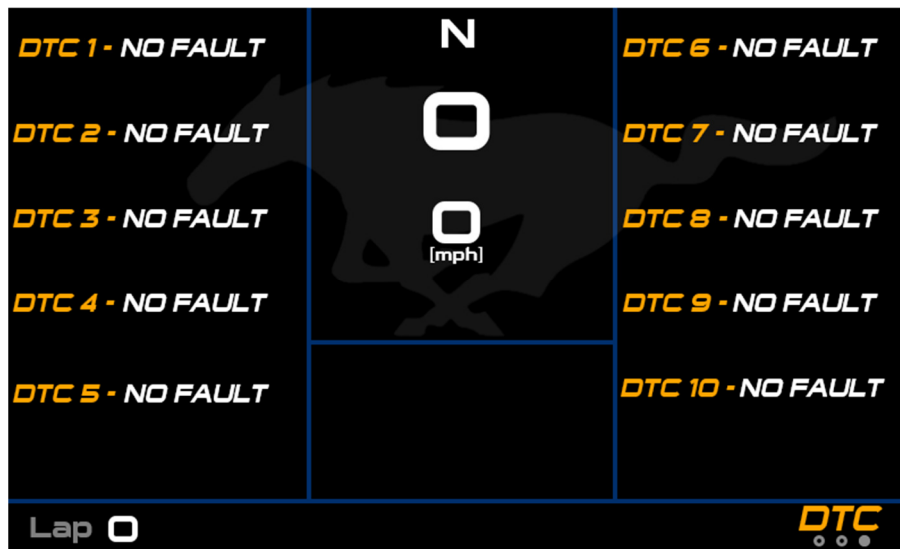

DTC

Gear Shift Lights

- Shift Light Display
- Illuminated **Red (Flashing)** – engine rev limit.
- Illuminated **Green** and **Yellow** and **Orange** – revs increasing.

2024 Mustang Dark Horse R

Up Shift Light 10
Up Shift Light 9
Up Shift Light 8
Up Shift Light 7
Up Shift Light 6
Up Shift Light 5
Up Shift Light 4
Up Shift Light 3
Up Shift Light 2
Up Shift Light 1

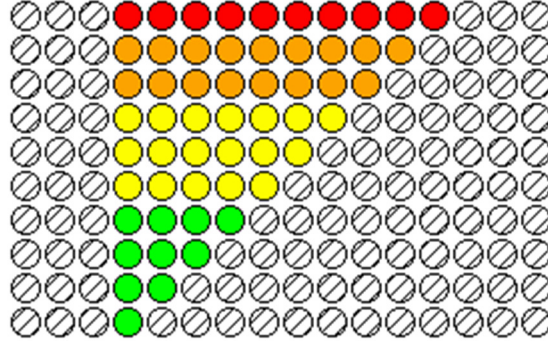

Other Dash Lights

- ABS Lamp: The bottom light on either side of display will illuminate yellow during an ABS fault.
- Right turn signal: The top light on the right side of display will illuminate blue when right turn signal is active.
- Left turn signal: The top light on the left side of display will illuminate blue when left turn signal is active.
- Pit switch: When pit switch is active all lights will illuminate blue and flash.

Alarms

- A red alarm bar will appear in the center and display an alarm message if an alarm is triggered.
- Three red lights on either side of the display will illuminate and blink if an alarm is triggered.
 - To clear alarm, press the “Alarm” button on the steering wheel.

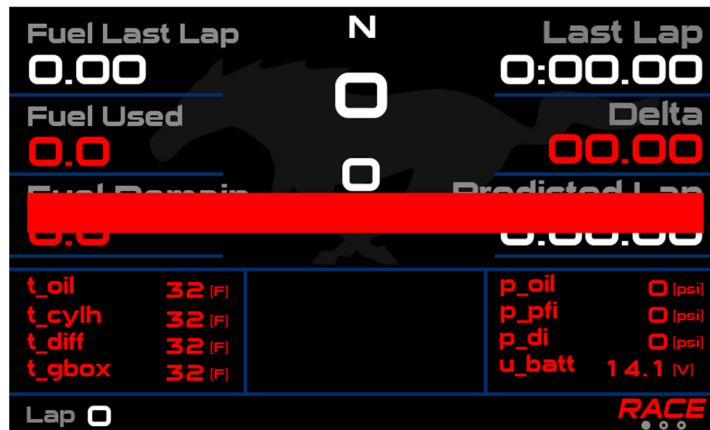



FORD PERFORMANCE

2024 Mustang Dark Horse R

List of Configured Alarms

MESSAGE	ACTION	REASON FOR ALARM	NOTE
OIL PRES LOW	CLUTCH IN – STOP VEHICLE DO NOT DRIVE Inspect Oil System – Review Data	Oil Pres < 100 kPa when RPM > 2000 for 0.5 sec	
COOLANT HOT	STOP / PIT Inspect Cooling System	Engine Coolant Temp > 112 C for 5 sec	
FUEL PRES LOW	STOP / PIT Inspect Fuel Pressure	Fuel Rail Pressure < 275 kPa and RPM > 500 for 2 sec	
ENG OIL HOT	STOP / PIT Inspect Oil Level and Cooling System	Oil Temp > 140 C and RPM > 500 for 2 sec	
GBOX HOT	STOP / PIT Inspect Gearbox Cooling System	Gearbox Temp > 135 C and RPM > 2 sec	
DIFF HOT	STOP / PIT Inspect Diff Oil Level, Pump & Cooling System	Diff Temp > 140 C and RPM > 500 for 2 sec	Driver use Diff Pump Override if Pump OFF
4 LITERS LEFT	Pit for Fuel Less than 3 Liters left in collector	Fuel Cell Collector Level Sensor Tripped	Premature collector light may indicate lift pump failure
NO ABS COMMS	SLOW / PIT Inspect ABS	ABS INACTIVE Over-current or Fault Shutdown	Driver check ABS Power switch
BATT V HIGH	PIT – Inspect Alternator	Battery Voltage > 16 V for 0.5 sec	
BATT V LOW	Charge / Replace Battery PIT – Inspect Alternator	Battery Voltage < 11 V for 1 sec	
FUEL RESET		Request to reset fuel level has been received	
PUMP OUT		Request to override fuel pump has been received	
REV MATCH		Rev match state has changed ON to OFF or OFF to On	
PCM ASLEEP	STOP / PIT Inspect wiring and PCM	PCM has stopped communicating with the dash	

DIAGNOSTIC PORTS

- Three diagnostic ports located in passenger footwell: ABS, MoTeC, OBD-II
 - OBD-II port used for communicating with PCM.
 - ABS port used for communicating with the BOSCH ABS M5 module and brake bleeding.
 - MoTeC is used for communicating with the MoTeC C187 Display





FORD PERFORMANCE

2024 Mustang Dark Horse R

Auto Rev Match

- When auto rev match switch is on, engine will auto rev match for downshifts.
- Is disabled for 2-1 downshift even if switch is on.
- Safe to downshift from 6-5 when all shift lights are not illuminated.
- Safe to downshift in any other gear when first shift light is illuminated.
- **Note:** Rev match will not activate upon downshift if RPM will exceed maximum engine speed

6. Calibration & ProCal TOOL

- Powertrain Control Module (PCM) calibration updates will be distributed to all owners by the ProCal tool and program. Ford Performance has logged the serial numbers for the ProCal tools supplied with each vehicle and will allow updates via the online data base. The procedure to do this is shown below. The ProCal tool also can also aid with other diagnostic procedures.

Install ProCal Software on Computer

- Navigate your browser to <https://performanceparts.ford.com/download/> and click on “ProCal 4 Installer Download (.zip)”

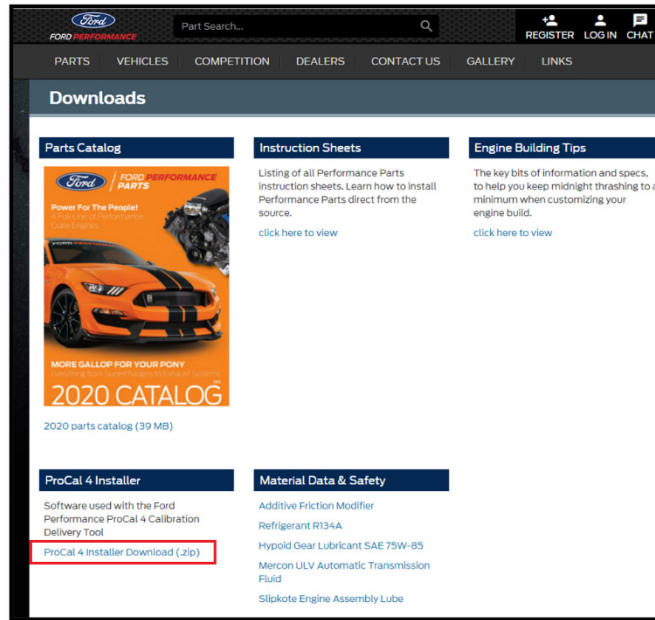

- Extract the files to your computer in a memorable location and run the “setup” file. Follow the prompts to install ProCal.

Updating ProCal Firmware

- Connect the ProCal tool with the USB cable provided and plug it into the computer.
- Open ProCal with the desktop icon (or from the start menu).

Attention: Some company networks may have security set to block access to downloads. Please contact your network’s IT administrator if you have problems connecting.

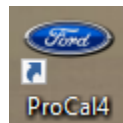

- If database version updates are available, select “Yes.”

2024 Mustang Dark Horse R

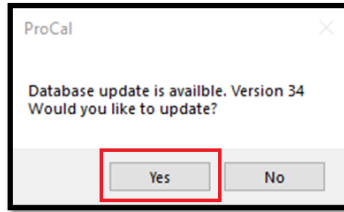

- If PID updates are available, select “Yes.”

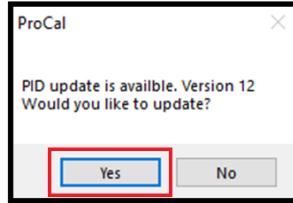

- When prompted Disconnect the USB cable and plug it back in to power cycle the ProCal. Press “O.K.”
 - Note: The ProCal tool may take a minute to load.

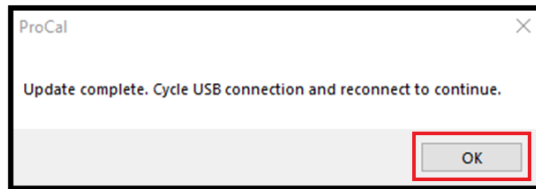

- The ProCal Device Information should populate. The software version will have to be updated to at least a 2.204 version to flash the calibration to the Dark Horse PCM. If this is not a high enough version press the “Update” button to update the firmware. Follow the prompts to update.

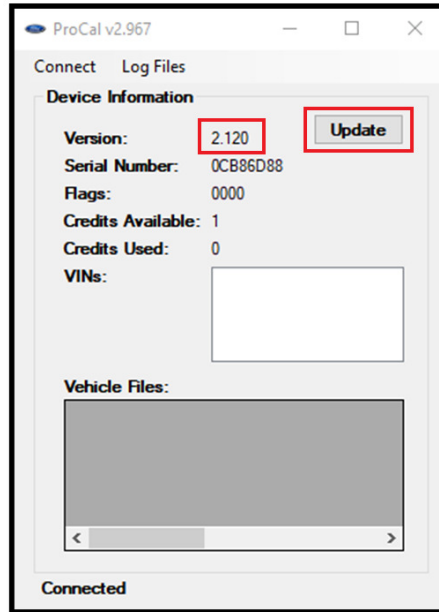

Flashing Calibration into the Vehicle

Note: The Dark Horse R requires a “Force Flash” be done when updating the PCM calibration. This does require a special procedure and unlock code.

2024 Mustang Dark Horse R

- Plug the ProCal into the OBDII port of the vehicle.



- After the PROCAL loads, press and hold "ABOUT DEVICE" for 5 seconds.



- Enter the code "1, 2, 3, 4, 5, 6, 7, 0, 0, 0"



- Press "PROGRAMMING."

2024 Mustang Dark Horse R



- Press and hold “CONTINUE” for 5 seconds.



- Press “CONTINUE.”

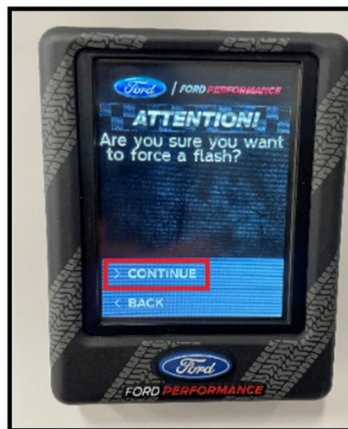

- Select the file to flash.

2024 Mustang Dark Horse R

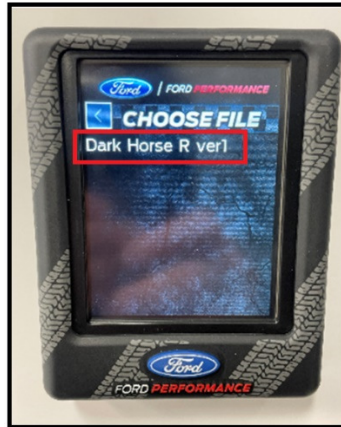

- When prompted, turn the ignition switch off, the flash is complete.



Learning the Misfire Profile

- If any of the following components have been replaced it is required that the following procedure be performed so that the crank position is calibrated, and the misfire monitor can properly function:
 - Powertrain Control Module (PCM)
 - Crank Position Sensor
 - Engine
 - Transmission (replaced or re-installed)
 - Clutch (replaced or re-installed)
 - Flywheel (replaced or re-installed)

Step 1: Confirm the ProCal tool has been Updated.

- Plug the ProCal tool into the diagnostic port of the vehicle.
- Start the engine.
- Select "SERVICE FUNCTIONS"

2024 Mustang Dark Horse R

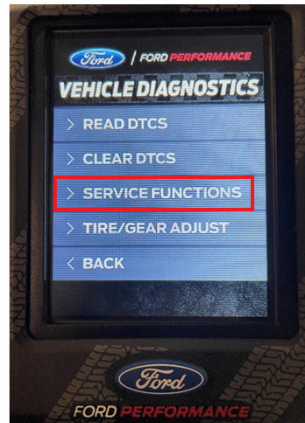

- Select "DIAGNOSTICS & TOOLS"

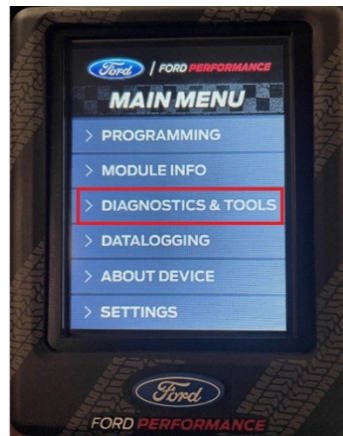

- Select "Crank Relearn"

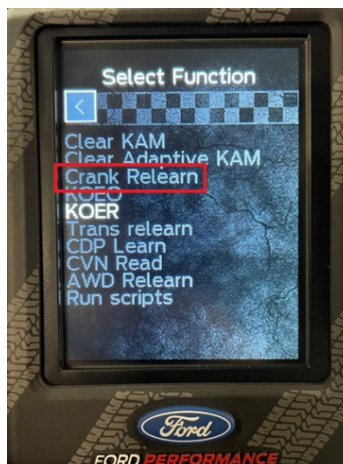

- Follow the prompts. NOTE: The engine will need to be warm.

2024 Mustang Dark Horse R

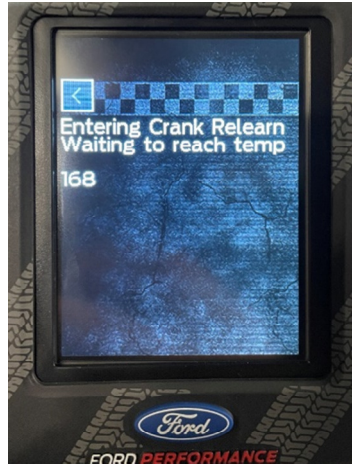

- Raise the engine RPM with the accelerator pedal and fully release the pedal quickly.

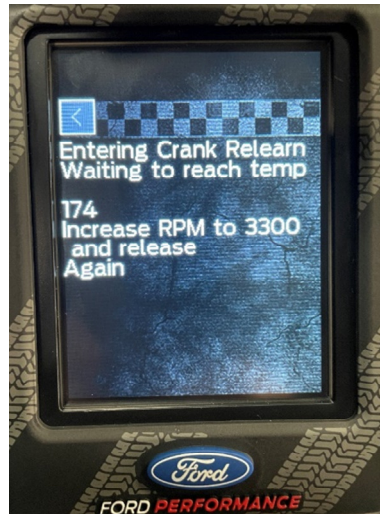

- The ProCal tool will report when the procedure is complete.

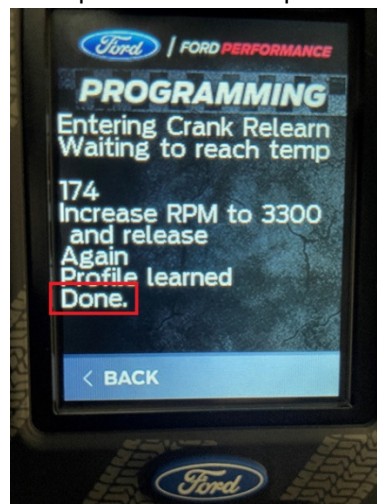

2024 Mustang Dark Horse R

6.0 ELECTRICAL SYSTEM

Important Electrical Connections

- Located on passenger side of transmission tunnel. Can be identified with an orange zip-tie.
 - Radio Power
 - IMSA Transponder Power
 - Radio Push-to-Talk

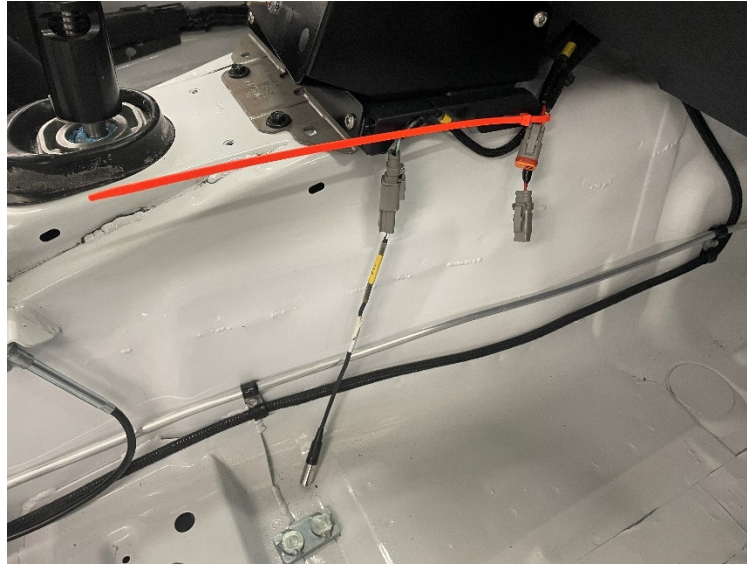

Spare Power

- Under hood (Switched "ON" when Master Switch is "ON")
 - 12V 20A – 1 Available

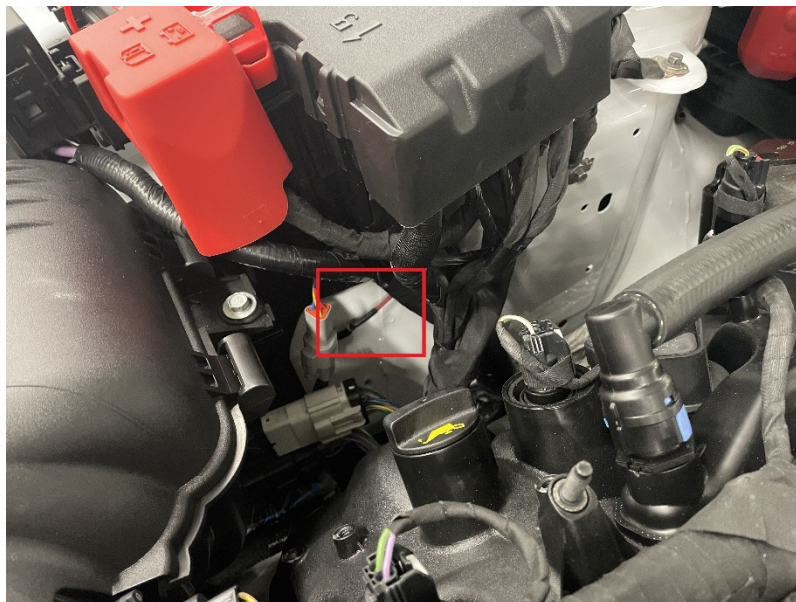

2024 Mustang Dark Horse R

- Cockpit (Switched “ON” with cockpit spare switches)
 - 12V 10A – 1 Available (Spare 1 Switch)
 - 12V 20A – 1 Available (Spare 2 Switch)

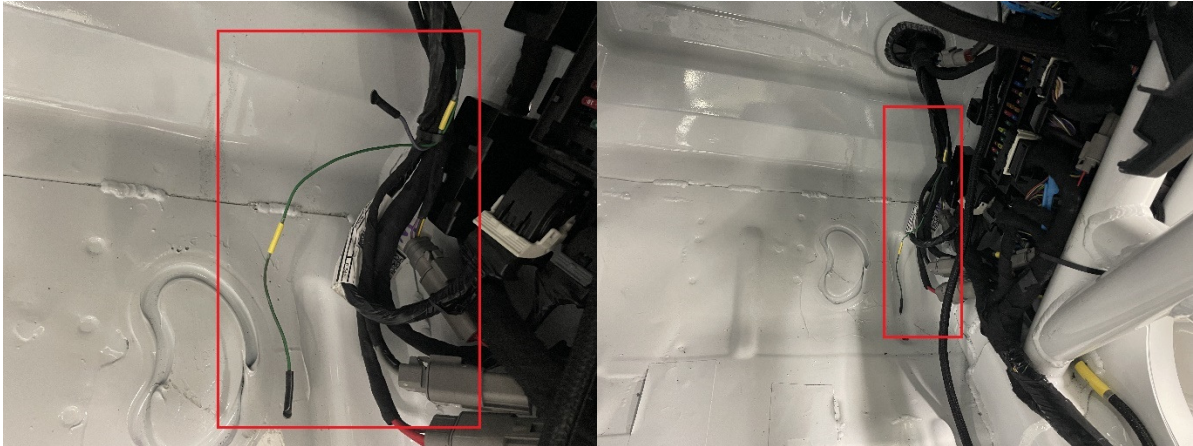

Spare Sensors

- Located under the dash, above the passenger footwell. Can be identified with an orange zip-tie.
 - 5V Analog Sensors – 8 Available
 - Spare Temp Sensor – 1 Available
 - Spare CAN Channel to MoTeC C187 – 1 Available



Main Breaker & Fuses

- The main breaker is located under the hood, mounted to the passenger firewall. This will disconnect all battery power to the vehicle.
- Main fuse panel is located under the hood, mounted above passenger wheel well.
- Body Control Module fuse panel is located on the passenger a-pillar on the interior of the vehicle.
- PCM/Diff Pump fuse panel is located under the hood, mounted to the passenger firewall.



FORD PERFORMANCE

2024 Mustang Dark Horse R

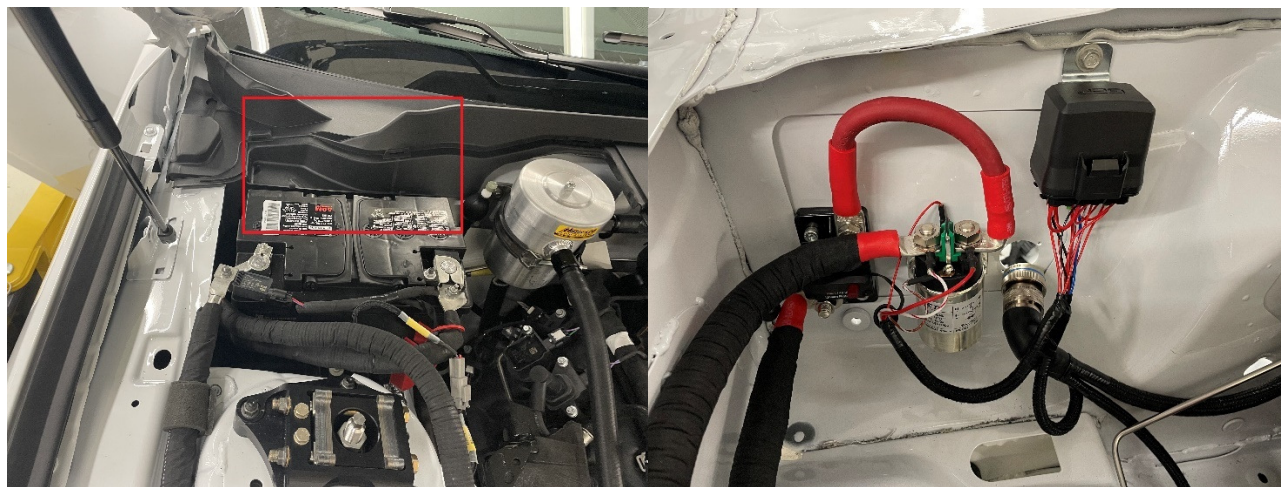

See Wiring files for additional information.



2024 Mustang Dark Horse R

7.0 ENGINE

7.1 Engine Architecture

Engine Architecture	
Configuration	V8
Capacity	5,000cm ³
Bore x Stroke	93.0mm x 92.7mm
Compression Ratio	12:1
Target Cylinder Head Temperature	82-115C (180-239F)
Target Charge Air Temperature	Follows ambient temperature
Target Oil Temperature	82-110C (180-230F)
Target Oil Pressure	450-700kPa (65-101psi)
Target Fuel Pressure	500kPa (73psi)
Firing Order	1-5-4-8-6-3-7-2

- Engine Specifications
 - 5.0L four valve per cylinder Coyote V8 Engine prepared by Ford Motorsports
 - Upgraded engine oil cooling system
 - Upgraded crankcase ventilation with an oil catch can and drain back lines
 - Race oriented exhaust system with long tube 4-1 equal length headers

2024 Mustang Dark Horse R

Engine Overview

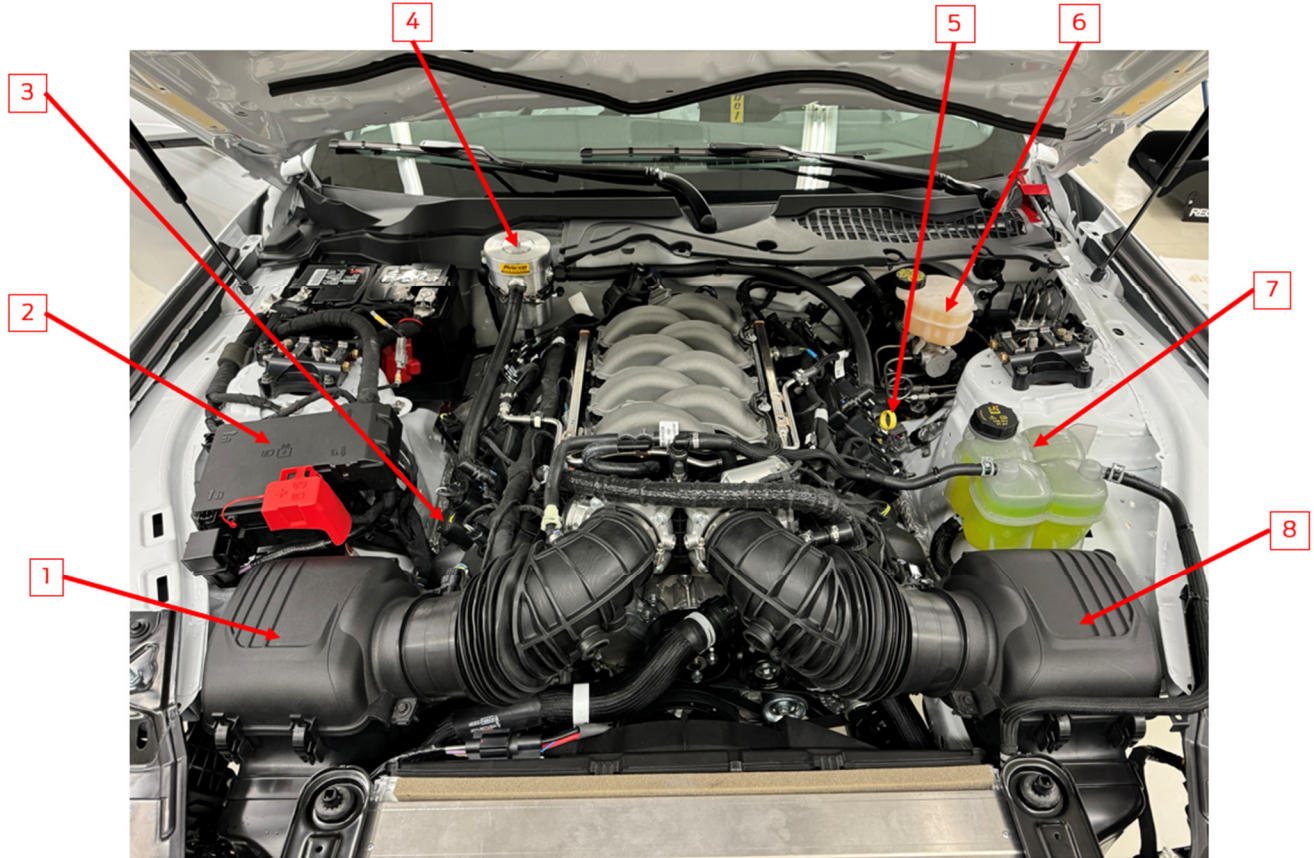

1	RH Air Cleaner	5	Engine Oil Dipstick
2	Vehicle Power Distribution Box	6	Brake Master Cylinder Reservoir
3	Engine Oil Fill Cap	7	Engine Coolant Reservoir
4	Catch Can/ Breather	8	LH Air Cleaner



FORD PERFORMANCE

2024 Mustang Dark Horse R

7.2 Engine Oiling System

Oil Flow Diagram

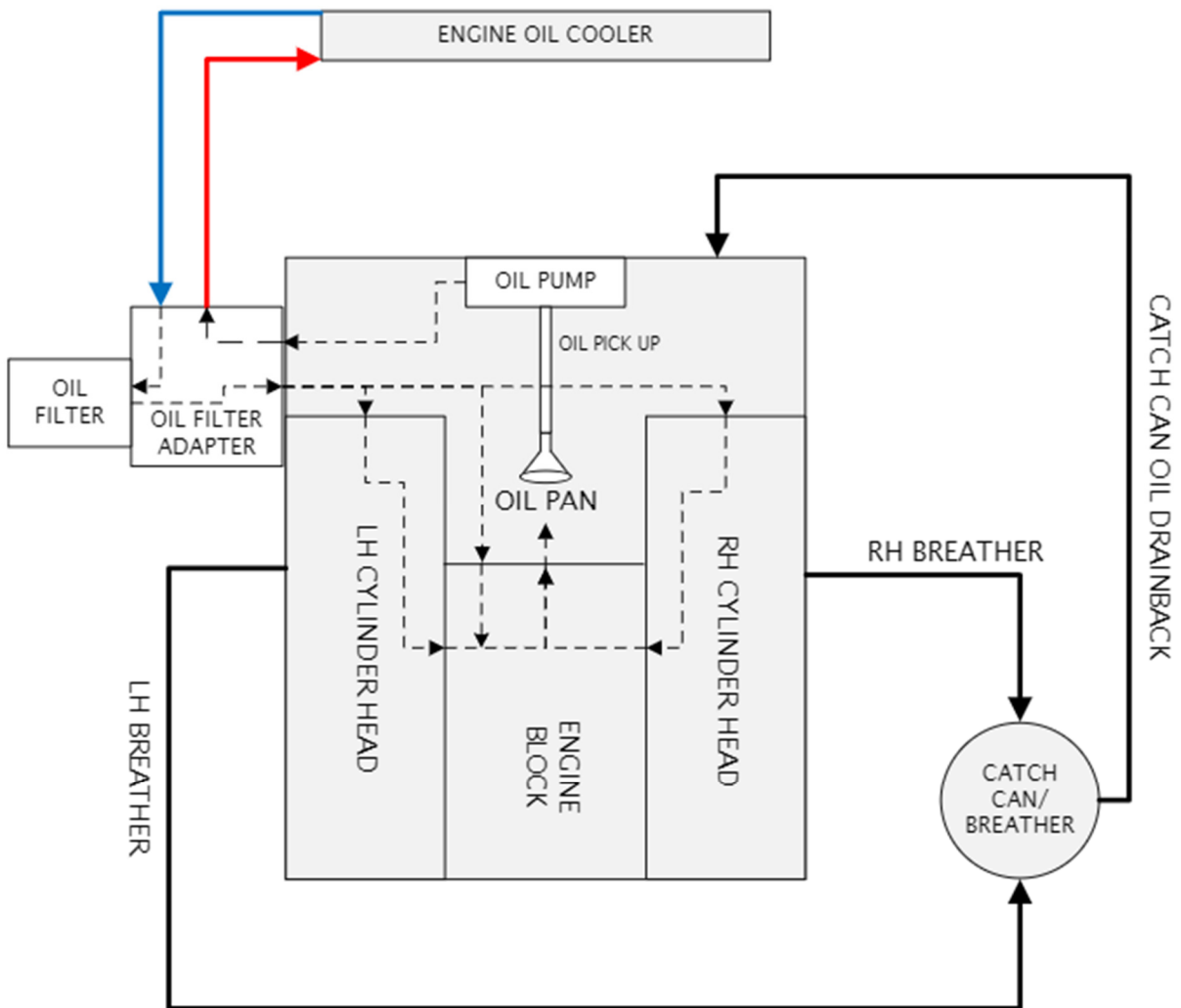

- Oil Type: MotorCraft 5W-50 Full Synthetic Oil or Similar
- Oil Filter: FL-500S
- Oil Capacity: 12 Quarts (11.32 Liters)- Fill to low level mark on dipstick.
- Note: The Engine Oil Thermostat has been permanently opened to allow for maximum oil flow to the oil cooler and may require a longer warmup period. Monitor engine oil temperature on the MoTeC steering during warmup.

2024 Mustang Dark Horse R

7.3 Engine Cooling System

Coolant Flow Diagram

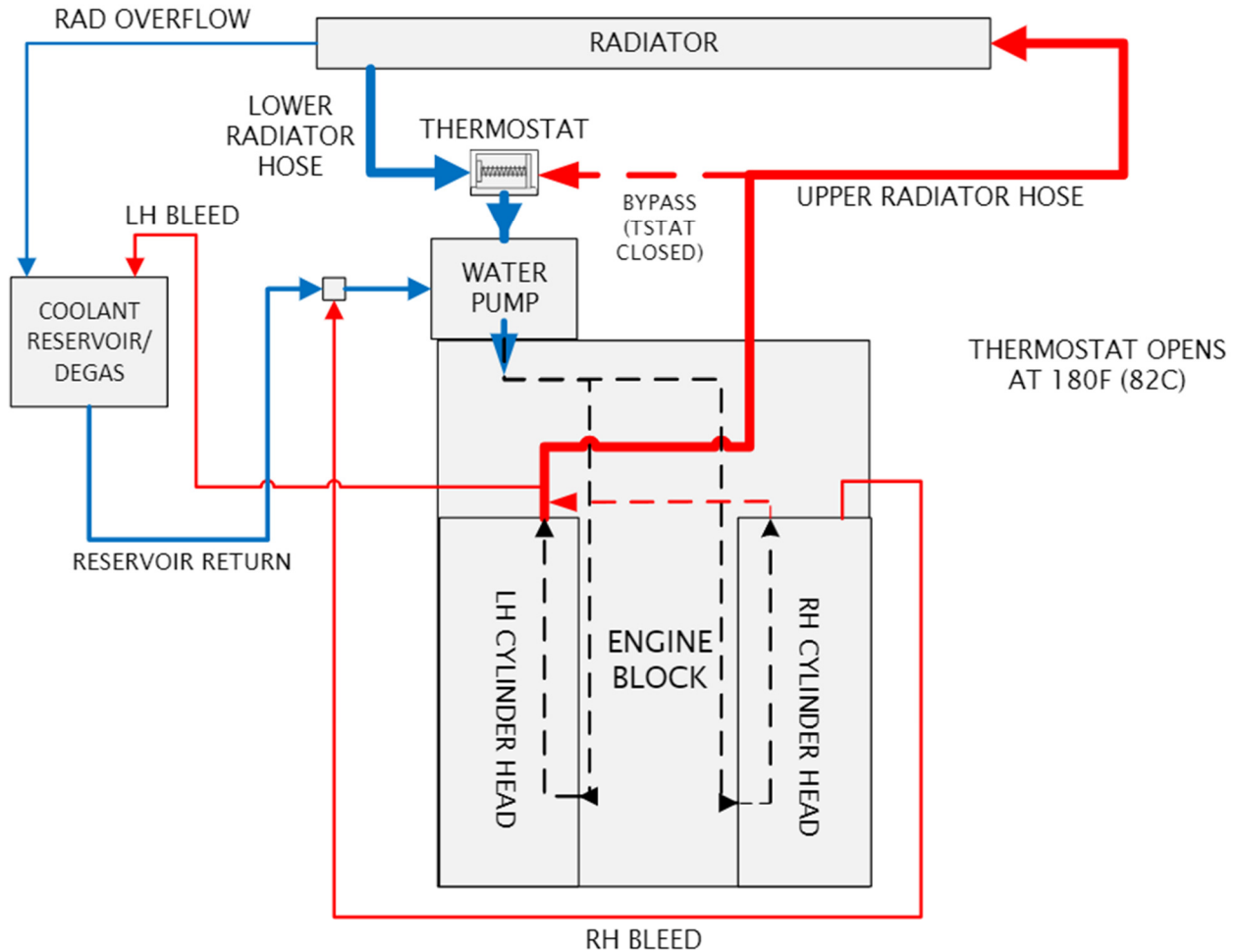

- Coolant Specification: Regulated per series coolant rules.
 - Note: The Dark Horse R is delivered with Motorcraft Yellow 50% Glycol Coolant for transportation in below freezing temperatures. Please refer to IMSA Mustang Challenge Series rules for coolants permitted for track use.
 - Coolant capacity: 11.7 Quarts (11.1 Liters)
 - For coolant refill an airlift system is recommended to reduce cooling system bleed and purge time and eliminate the potential for air locks.



FORD PERFORMANCE

2024 Mustang Dark Horse R

7.4 Engine Maintenance

1. Fill oil to just below the lower hole on the dipstick (Start with 12 qts of oil and add until intended level is reached). Recommended fill level to the lower hole on the dipstick to minimize oil aeration.
2. Change engine oil and filter after every race event, or 4 hours of operation, whichever is sooner
3. Spark plugs have a limited life expectancy and should be replaced after every event. In the event of a misfire, plugs should be replaced immediately. Motorcraft SP589 or CYFS12YT6, gap to 1.25-1.35 mm.
4. Monitor engine oil pressure over time to understand engine bearing wear by picking a consistent RPM and temperature to look for deviations.
5. Replace O2 Sensors after every 20 hours of usage.
6. Replace engine air filters (FA-2066) after each race weekend for optimal engine performance.
7. Check cylinder compression and leakage after every race event to monitor engine condition. If results do not meet the criteria listed below, consider an engine replacement, or rebuild.
 - a) The lowest cylinder pressure should be within 75% of the highest cylinder pressure.
 - b) Leakage should be less than 5% on any cylinder.

Complete engine rebuild is recommended after 40 hours of use, or 1 full race season. Monitor compression and leakage values as described above to determine the need for engine rebuild or replacement.

This is a sealed competition engine, contact Technosports for engine rebuild and replacement services.

Technosports, Inc.

34075 Autry St.

Livonia, MI 48150

Phone: 734-261-0060



FORD PERFORMANCE

2024 Mustang Dark Horse R

8.0 DRIVETRAIN

See BoM for list of part numbers and sources for service or replacements.

System	Make	Fluid	Fluid Spec	Sump Qty	Total Qty
Transmission	Tremec-3160	MERCON® LV ATF	XT-10-QLVC (WSS-M2C938-A)	2.5 qt (2.4 L)	3.5qt (3.3 L)
Axle	Ford 8.8" IRS 3.73	75W-85 Synthetic	XY-75W85-QL (WSS-M2C942-A)	1.57–1.65 qt (1.49–1.56 L)	4 qt (3.785 L)

8.1 Transmission – Tremec 3160 Six Speed

8.1-1 Shifter

Pattern: 6-Speed as shown

Operational notes:

- Damage to gearbox is not common under normal use.
- If shift quality degrades, first inspect linkage and bushings.
- Also, perform regular inspections of Transmission Mount assembly.

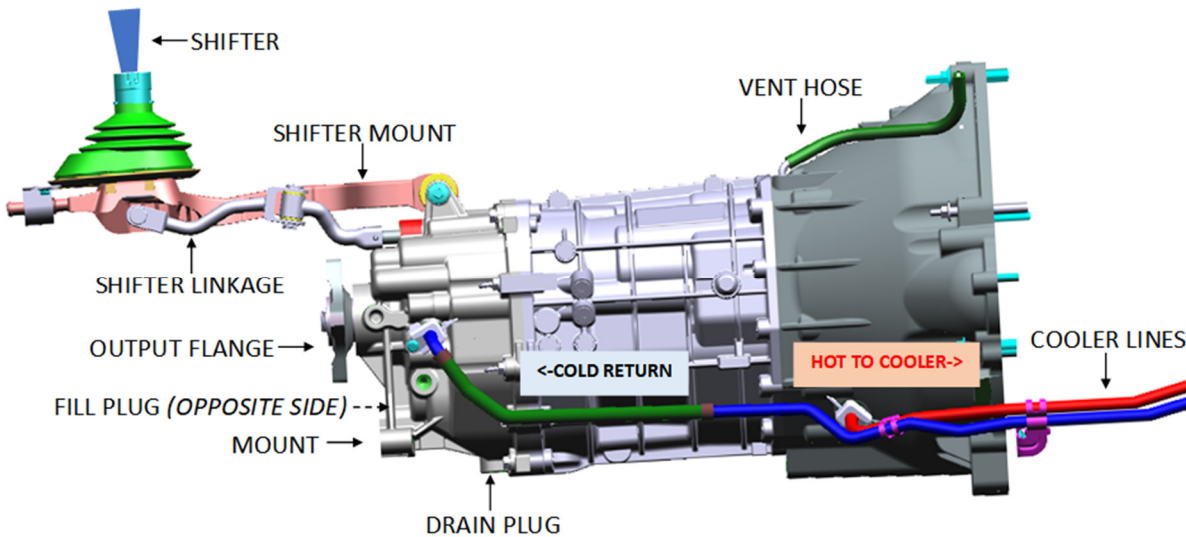
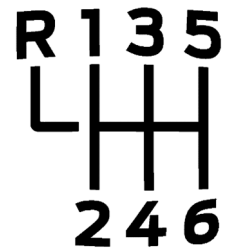

Gear	Gear Ratio
1st	3.253:1
2nd	2.233:1
3rd	1.611:1
4th	1.243:1
5th	1:1
6th	0.629:1
Reverse	2.955:1



FORD PERFORMANCE

2024 Mustang Dark Horse R

8.1-2 Plumbing

Drain and Fill plug locations shown (below, red)

Transmission is equipped with Air to Oil Cooler:

Front port is hot feed to Cooler

Rear port is cold return from Cooler

NOTE: Replace fluid frequently. Do not reuse fluid if temperature limit alarms.

8.1-3 Cooling

Transmission cooler is located ahead of front Driver-side Wheel.

System makes use of stock Dark Horse Engine Oil Cooler location.

Periodically inspect cooler face to ensure it is free of debris or damage.

8.1-4 Vent & Clutch Lines

Periodically inspect Vent Line assembly to ensure hose is seated, Passenger-side.

Custom Clutch line affixed via 90° fitting at port on Driver-side of Bellhousing.

Replace Clutch fluid and inspect lines if Clutch has overheated.

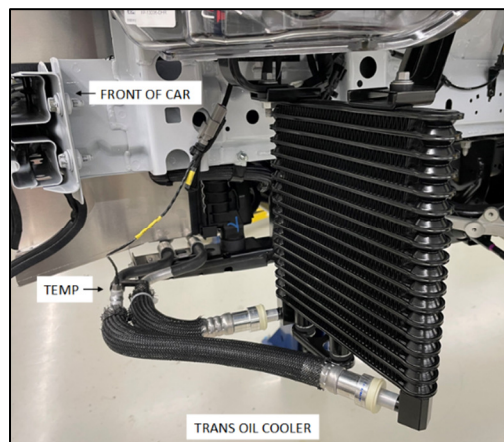
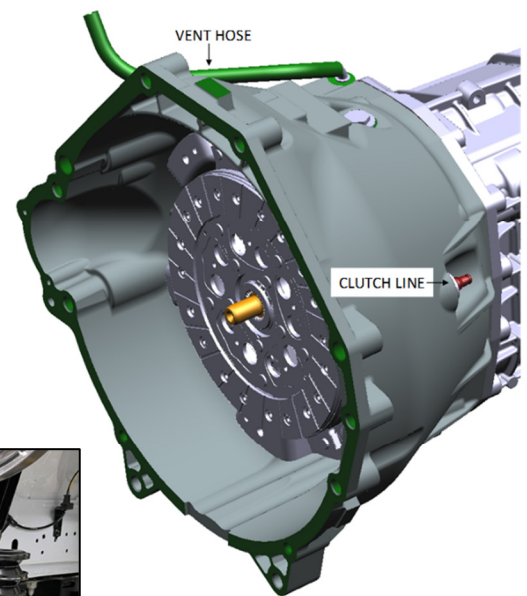
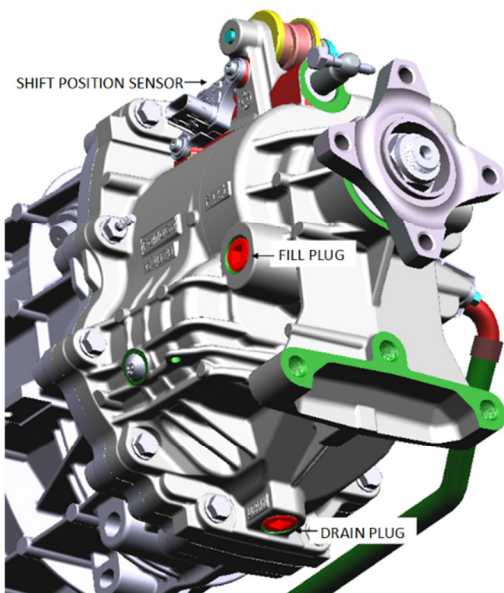

8.1-5 Fill Procedure

Fill sump of Transmission.

Turn on master power, start engine.

Cycle Trans Cooler Pump by putting vehicle in-gear and spinning Trans.

CAUTION: Do not let system run dry. Exercise safety when running.

Cooler and Pump are primed when fluid level does not drop upon pumping.

Top off to recommended fill quantity; fluid level should not exceed fill plug when pumping.

8.1-6 Drain Procedure

Remove drain plug to empty sump

Turn on master power, start engine.

Cycle Trans Cooler Pump by putting vehicle in-gear and spinning Trans.

CAUTION: Do not let system run dry. Exercise safety when running.

Cycle Trans Cooler Pump on for no more than 5 second intervals if near empty.

Fluid will pump from Coolers to sump in order to drain full Cooling system.

Optional: Remove return hose line in order to bypass pumping to sump

8.2 Driveshaft & Halfshaft – Ford Dark Horse Manual OE

Do NOT allow CVJ ends to hang unsupported. Do NOT allow wheel to hang via Shaft.

Periodically inspect the U-Joints and Bearing Mount to ensure they are snug and sealed

DO NOT DROP. Damage may not be visible. Discard and replace dropped or damaged units.

NOTE: Halfshafts have been equipped with a relief vent, see red straw visible via inlay below.

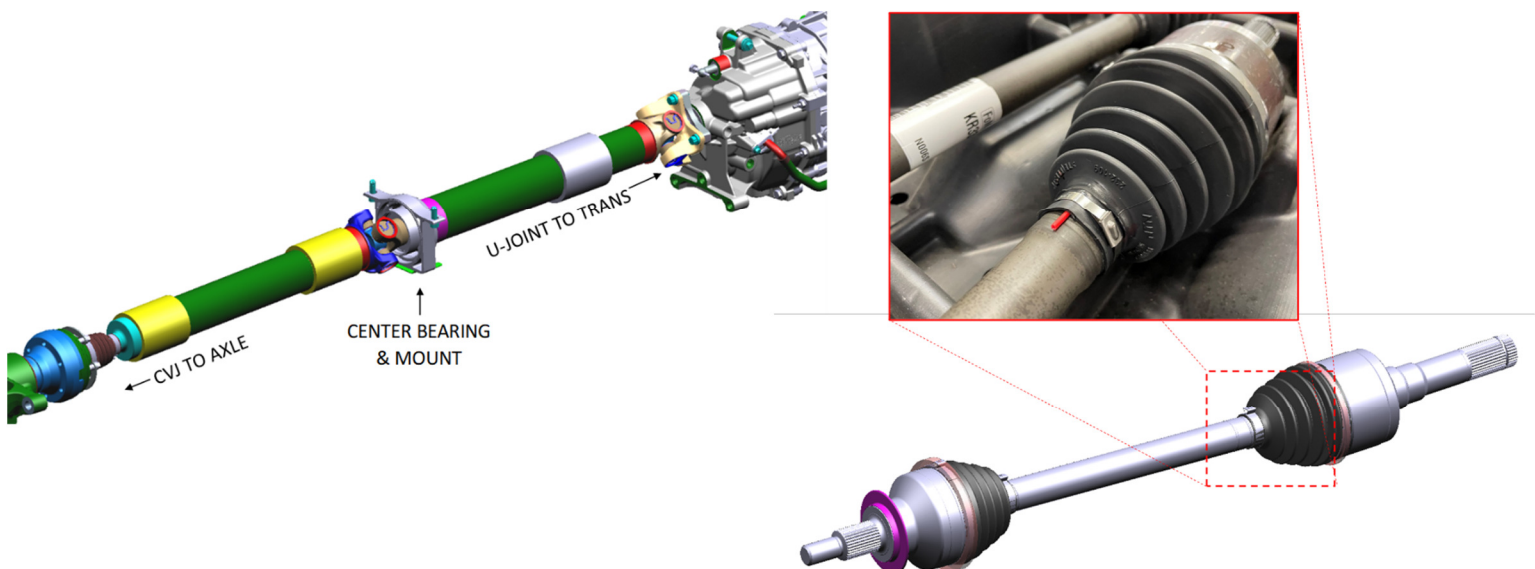

2024 Mustang Dark Horse R

8.3 Axle – Ford 8.8” IRS 3.73 Ratio

8.3-1 Plumbing & Cooling

Oil Cooler ports and Fill Plug highlighted, red:

Upper port is cold return from Cooler

Lower Cooler Port doubles as Drain Plug and hot feed to Cooler

Dedicated aftermarket Cooling Fans and Fluid Pump are used:

NOTE: Regularly clean or replace inline fluid filter screen to protect system from debris.

Replace fluid frequently. Do not reuse fluid if temperature limit alarms.

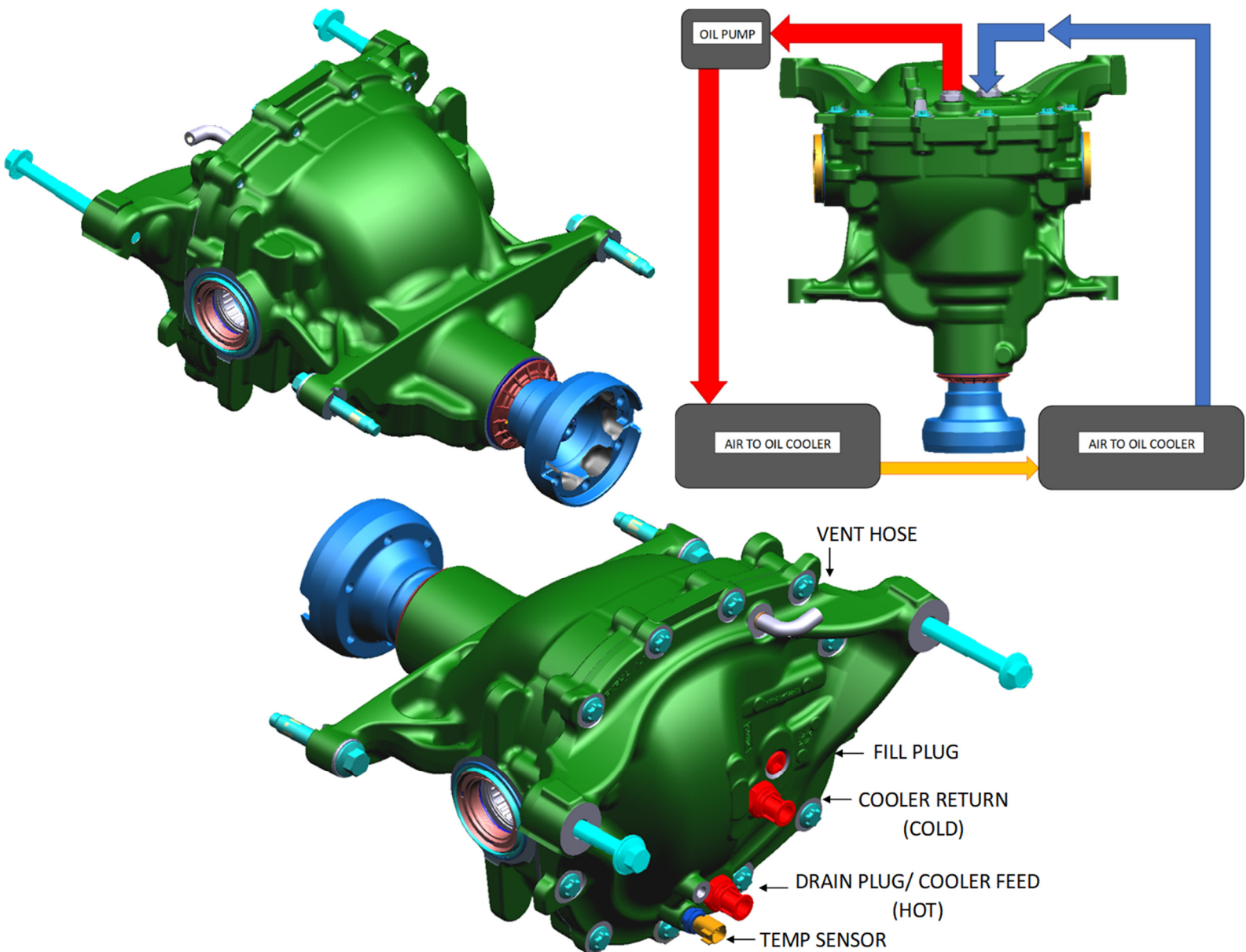



FORD PERFORMANCE

2024 Mustang Dark Horse R

8.3-2 Venting

Periodically inspect Vent Line assembly to ensure hose is seated

Proper Vent Line routing prevents water ingress into sump

8.3-3 Fill Procedure

Prepare system by filling sump of Axle

Turn on master power BUT DO NOT START ENGINE

Cycle Axle Cooler Pump on until fluid flows into sump from return Inlet

Or, until fluid in sump is consumed, then refill; do not run dry.

Cooler and Pump are primed when fluid level does not drop upon pumping.

Top off to recommended fill quantity; fluid level should not exceed fill plug when pumping.

8.3-4 Drain Procedure

Remove drain plug to empty sump

Turn on master power BUT DO NOT START ENGINE

Cycle Axle Cooler Pump on for no more than 5 second intervals

Fluid will pump from Coolers to sump for further draining

Optional: Remove return hose line in order to bypass pumping to sump



FORD PERFORMANCE

2024 Mustang Dark Horse R

9.0 FUEL SYSTEM

A 30-gallon fuel cell is located in the trunk of the vehicle.



Fuel cell fill plate, M6-1, torque to 3.5 Nm (30 inlbf)

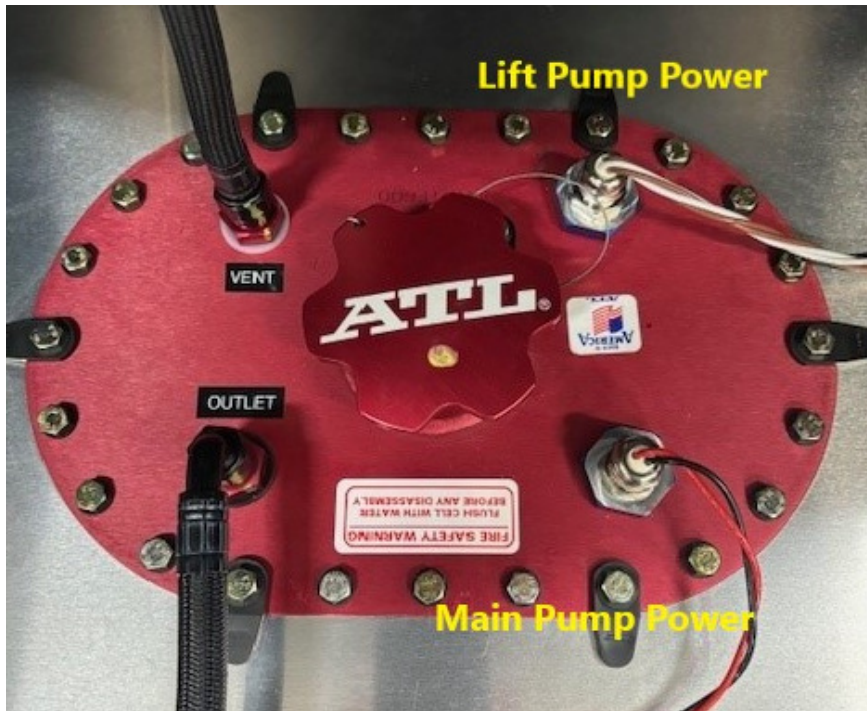

Fuel Pump Out Location

Female Fitting STA-SPT08.3655/L/JKV

Male Fitting STA-SPT08.7655/L/JKV



FORD PERFORMANCE

2024 Mustang Dark Horse R

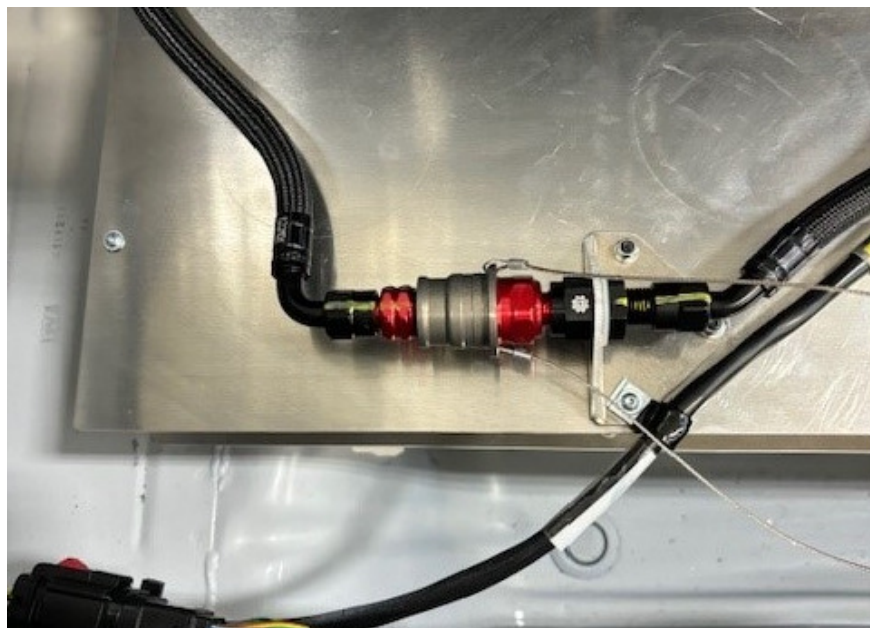



FORD PERFORMANCE

2024 Mustang Dark Horse R

10.0 Chassis Systems

Dampers

Any Internal operations to the dampers must be performed exclusively by an authorized Multimatic Service Center. See the “Key Contacts” section for contact information.

Any tampering with the internal components or valves may affect the specifications and the performance of the dampers.

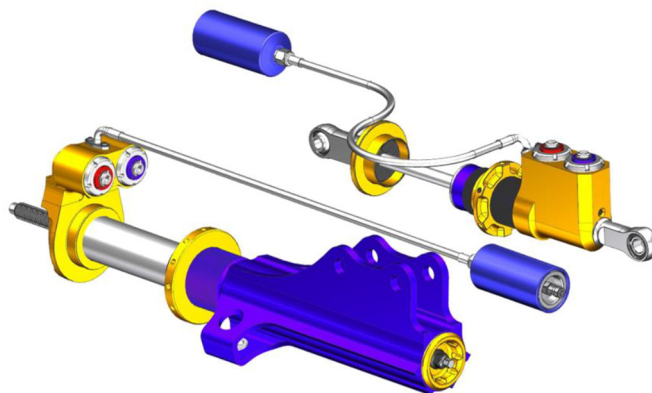

	Front	Rear
Fully Extended Length	480 mm (Top Mount to Lower Hub Bolt)	435 mm
Fully Compressed Length	360 mm (Top Mount to Lower Hub Bolt)	325 mm
Total Stroke	120 mm	110 mm
Reservoir Type	Remote	Remote
Adjustability	2-Way (LSB, LSR) 0-Soft, 11-Stiff	2-Way (LSB, LSR) 0-Soft, 11-Stiff
Maximum Body Diameter	95 mm	75 mm
Shaft Diameter	14 mm	14 mm
Piston Diameter	35 mm	35 mm
Spring ID	2.5 in	2.25 in
Nominal Spring Length	7 in	6 in
Nominal Motion Ratio	0.92:1	0.86:1



FORD PERFORMANCE

2024 Mustang Dark Horse R

Damper Adjustments

Both Front and Rear Dampers are equipped with low-speed bump and rebound adjusters. Damper Settings are specified in format **LSB-LSR**; ex. 4-8 is 4 Bump and 8 of Rebound. Adjustment range is from 0-Soft to 11-Stiff.

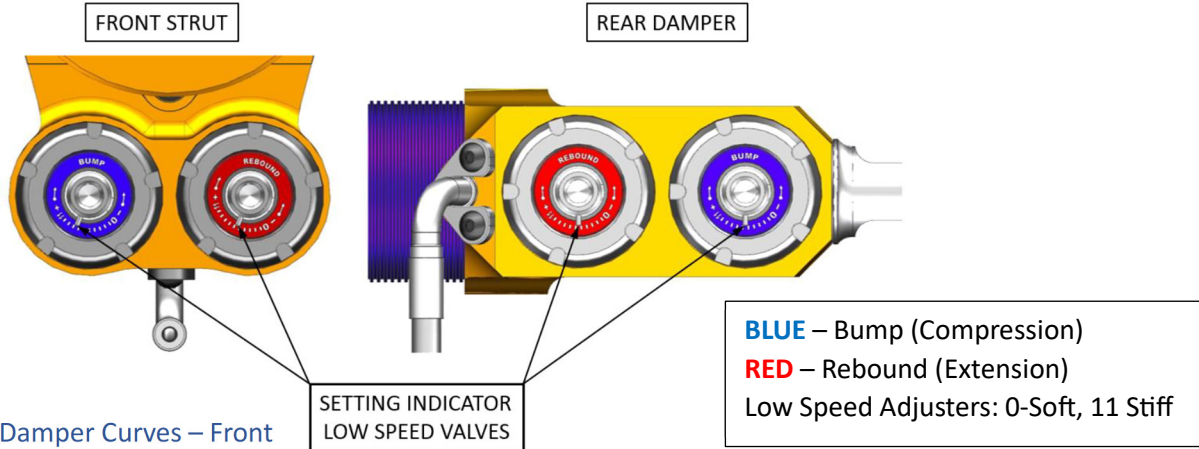

Damper Curves – Front

Front Damper Adjustment Range. (6-6 is highlighted)

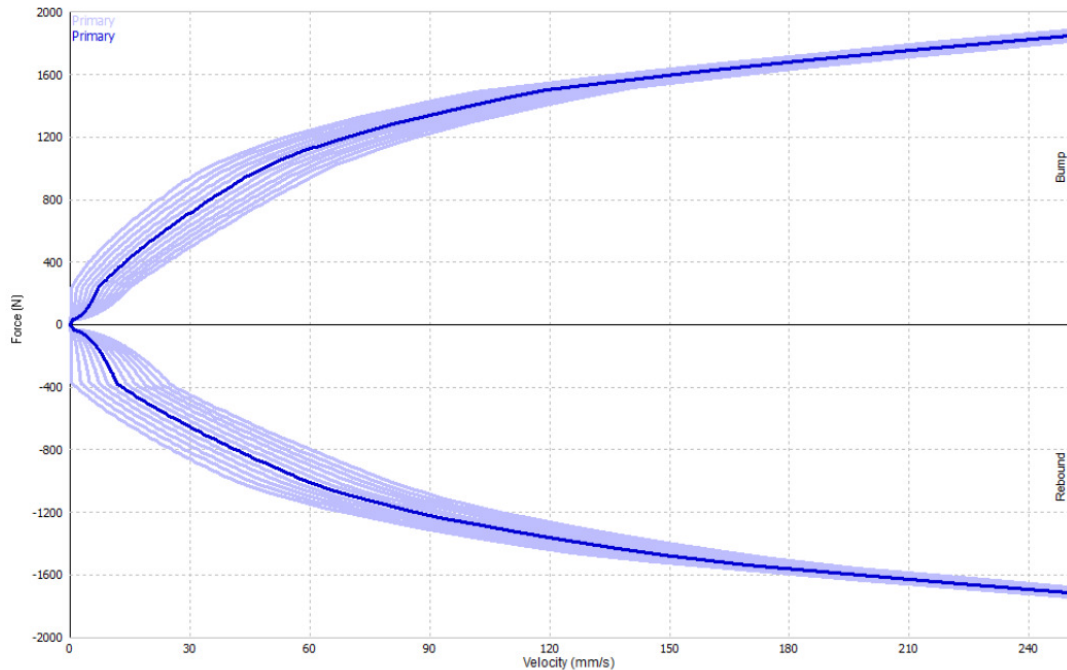

Damper Curves – Rear

Rear Damper Adjustment Range. (6-6 is highlighted)



FORD PERFORMANCE

2024 Mustang Dark Horse R

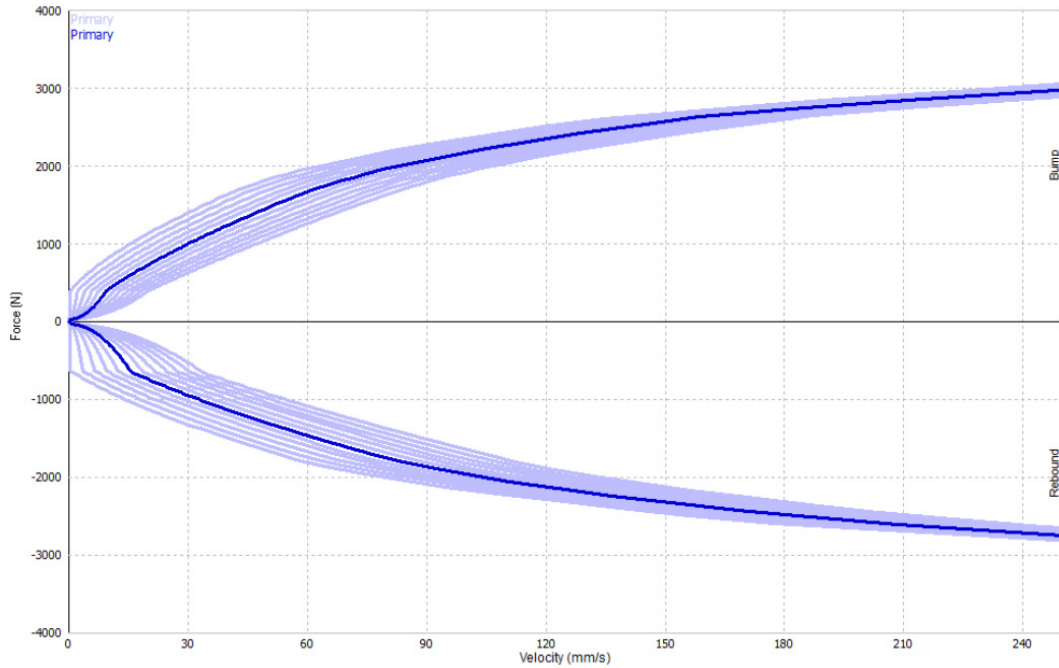

Ride Height Adjustment

Attention: Different race series may specify different minimum ride heights. Operator is responsible for maintaining compliance with respective series ride height requirements.

Ride Height is adjusted by adding or removing preload on the springs using the damper spring seats. Both front and rear dampers have a 2 mm/turn spring seat thread pitch.

Perch Adj. (Rounds)	Front [mm]	Rear [mm]
0.5	1.1	1.2
1.0	2.2	2.3
2.0	4.3	4.6
3.0	6.5	7.0
4.0	8.7	9.3
5.0	10.9	11.6
6.0	13.0	13.9

Ride height change is not exact and is an estimate based on a linear damper motion ratio. Exact spring seat adjustment effect on ride height will depend on multiple factors such as where the car is in overall ride height, static camber, and static toe. Please use this table as a relative guideline.



FORD **PERFORMANCE**

2024 Mustang Dark Horse R

Anti-Roll Bars

Both front and rear ARBs have adjustable drop-links, and the ARB may be disconnected by removing one drop-link.

	Front	Rear
PN	FR3Z-5482-J	FR3Z-5A772-E
Outer Diameter	34	24
Wall	5.7	3.6

Attention: The Darkhorse R ARB drop-links for both front and rear have unique hardware kits and must be installed correctly.

Front ARB

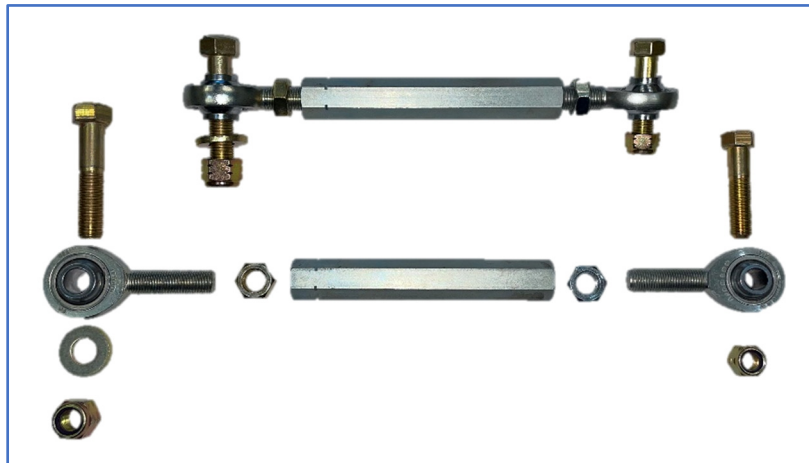

Front ARB Drop-Links Hardware Kit

2024 Mustang Dark Horse R



The large rod end and left-hand thread of the drop-link (denoted by the slots) attach to the ARB.

The small rod end and right-hand thread of the drop-link attach to the strut tower with top hats.

Rear ARB

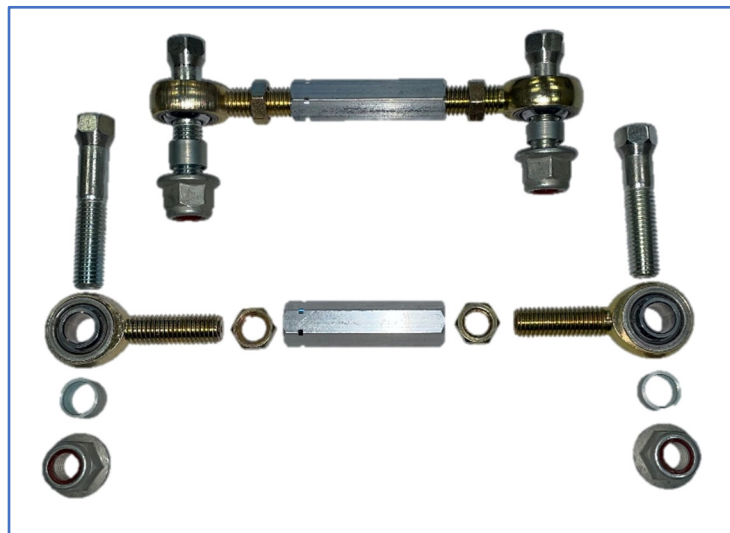

Rear ARB Drop-Links Hardware Kit

2024 Mustang Dark Horse R



The left-hand thread (denoted by the slots) of the drop-link, short bolt and small bushing attach to the ARB.

The right-hand thread of the drop-link, large bushing and long bolt attach to the control arm.

Camber Adjustment

Attention: Different tire suppliers and race series may specify allowable static camber limits. Operator is responsible for maintaining compliance with posted static camber requirements.

Front Camber Adjustment



Shim Type

Thickness [mm]

Approx. Camber Change [deg]



FORD **PERFORMANCE**

2024 Mustang Dark Horse R

Thick	5.78	0.48
Thin	1.15	0.10

*12mm of Shim required to change camber by 1 deg

Rear Camber Adjustment

Rear Camber Adjustment on Darkhorse R is unchanged from production.

Toe Adjustment

Attention: Different tire suppliers and race series may specify allowable static toe limits. Operator is responsible for maintaining compliance with posted static toe requirements.

Front Toe Adjustment

Front Toe Adjustment on Darkhorse R is unchanged from production.

Rear Toe Adjustment

The Rear Toe-link on Darkhorse R is infinitely adjustable.

2024 Mustang Dark Horse R

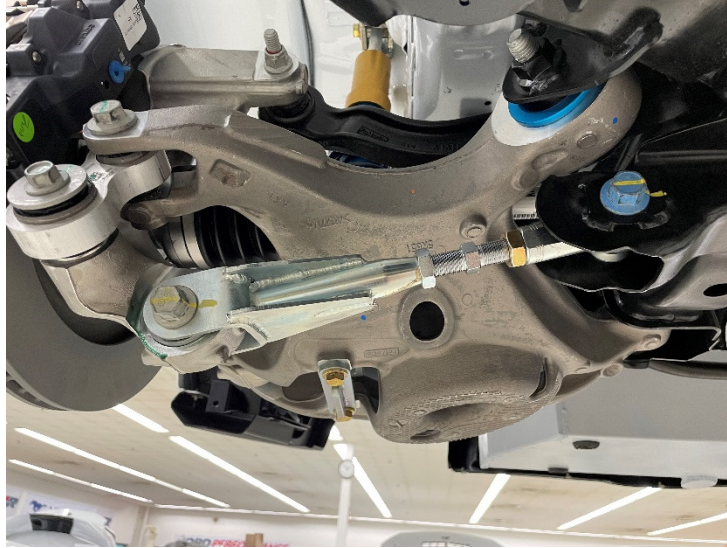

Steering System

The Darkhorse R steering system contains a Rack and Pinion setup with Electric Power Assist. The Steering System with the Darkhorse R only calibration is only available from Ford Performance.



Braking System

The Darkhorse R utilizes a Brembo Brake System:

Attention: Please refer to Brembo's Mustang Darkhorse R Brake System Technical Bulletin for more information.

- Brake Fluid Specification: Brembo HTC 64T



FORD PERFORMANCE

2024 Mustang Dark Horse R

- Part Number = 04816420
- Front Pad Information:
 - Compound is known as RB340 or BRP34
 - Full part number = BRP34-1980WA.29B
 - All front pads will come pre-bedded.
- Rear Pad Information:
 - Rear pad is specifically designed for the Darkhorse R.
 - There will be two part numbers released. There will be a “prototype” part number which will be installed in the first 50 cars and then it will switch to the “production pad”.
 - Prototype Pad Part Number = 90.7552
 - Production Pad Part Number = P1309.17.F01

Brake Bleed Procedure

Attention: When bleeding the brakes on Darkhorse R you must bleed BOTH the Bosch ABS M5 unit and the brake system

Brake Bleeding Procedure:

1. Bleed the brake system by performing a vacuum bleed on all four calipers.
Note: Vacuum bleed both bleed screws on the rear corners
 2. After bleeding the Bosch M5 Race ABS Unit, perform a manual brake bleed on all four corners to ensure there is no air trapped in the entire brake system.
- Bleed the Bosch M5 Race ABS unit utilizing the “Repair Bleeding Wizard” on the **RaceABS** Software. Please refer to the [Bosch M5 ABS kit operations manual](#), section 10.2.4 ‘Repair Bleeding Wizard’ and follow the procedure to bleed your Bosch M5 Race ABS unit.
 - The RaceABS “Repair Bleeding Wizard” should be done whenever the ABS module is exposed to atmosphere or if there is air trapped in the system despite all other bleeding efforts.
 - Performing the RaceABS “Repair Bleeding Wizard” too often could cause the filters in the ABS module to become clogged with debris.

The Torque Spec for Bleed Screws are temperature dependent:

- <100C: 14 +/- 2 Nm
- >100C: 9 +/- 1 Nm

Anti-Lock Brake System

This car is equipped with a Bosch Motorsports M5 Race ABS System with a Darkhorse R specific ABS calibration. Calibrations are to be supplied only by Bosch Motorsports and installed only by Bosch.



FORD PERFORMANCE

2024 Mustang Dark Horse R

There are 12 ABS settings, controlled by a rotational switch on the center console. The ABS can be turned ON or OFF by a toggle switch on the center console, additionally setting the ABS dial to Position 12 will turn the ABS OFF. When ABS is off the ABS MIL will illuminate on the center console.

If there are any logged ABS faults, the ABS MIL will illuminate.

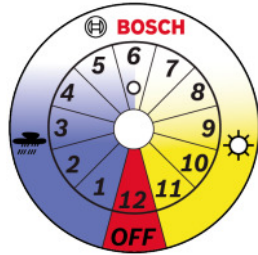

ABS M5 scale, standard



ABS Modes

ABS Calibration Sweep: FordDHR_v01		
Description		Notes
Map 1	Heavy Wet Conditions	Earliest system activation; Most amount of intervention
Map 2	Normal Wet Conditions	Default wet map
Map 3	Damp/Drying track	Greater overall slip than wet maps, less lateral support
Map 4	Low grip; Greatest lateral support	Lowest allowed rear slip of dry maps
Map 5	Low grip; Balanced	Intended for low grip tracks/tires that have fallen off
Map 6	Medium grip; Lower slip and cycle rate	Cycle rated reduced and earlier intervention compared to map 8
Map 7	Medium grip; lower slip	Lower overall slip allowed compared to map 8
Map 8	Medium grip	Default map. Intended for average grip tracks
Map 9	High grip	Intended for high grip tracks that prefer more modulation before intervention
Map 10	High grip; latest intervention	Later intervention and higher cycle rates compared to map 9
Map 11	High grip; latest intervention and lowest lateral support	Higher slip and greater rear slip compared to map 9
Map 12		OFF

Wheels and Tires

Wheels

	Front	Rear
PN	M-1007-SR1MB19X105F	M-1007-SR1MB19X11R
Size	19.0" x 10.5"	19.0" x 11.0"
Offset	ET24	ET52.5
FP Parts Extended Stud and Nut Kit	M-1107-E	



FORD PERFORMANCE

2024 Mustang Dark Horse R

Michelin Tires

Tires for the 2024 Mustang Challenge season will be 295/30ZR19 Michelin Pilot Sport FP, with the same spec on all four corners. This tire was developed specifically for the Mustang Challenge series and is designed to work with the 10.5in front wheel as well the 11in rear. Both tire specs are not DOT approved and should not be used on the street.

	Size	Name	Part Number
Slick	295/30ZR19	Pilot Sport FP - Slick	44542
Wet	295/30ZR19	Pilot Sport FP - Wet	89892

Michelin Tire Care

Tires should be stored in a cool, dry location away from direct sunlight when not in use. Store tires away from any volatile compounds, such as gasoline. Be aware of potential heat sources, such as generator exhausts, when deciding where to store or stage the tires.

Try to keep records of the age and mileage on each tire, rotating stock to use the oldest tires first, when possible. The slick tire is equipped with “wear pins” which enable measurement of the tread depth on the slick tire in various positions across the surface of the tire. For questions on measuring tread depths and properly utilizing this data for vehicle setup, contact your Michelin series manager.

Mounting should only be done by a professional with proper equipment. A protective cage should be used for bead seating and the bead seating pressure should not exceed 60psi. The direction to mount each tire is indicated on the tire sidewall. Dismounting tires has a high likelihood of damaging tire beads. If tires are dismounted with the intention of being used again, a thorough inspection of the tire should be conducted **before** remounting. Contact your Michelin series manager for assistance.

Michelin Tire Settings

Attention: Camber and tire pressure settings are a critical part of tire usage. Guidelines for each event will be provided by your Michelin series manager.

It is recommended that nitrogen or dry air be used for tire inflation since they provide a more predictable and consistent pressure gain from cold to hot pressure. Try to reduce all other sources of moisture in the tire mounting process. Tires can also be purged after mounting, sometimes numerous times, with dry air or nitrogen to help remove excess moisture within the tire.

For technical or performance questions about tires, please contact your Michelin series manager.



FORD PERFORMANCE

2024 Mustang Dark Horse R

11.0 SET UP AND RECOMMENDATIONS

For optimum performance of your FP-DHR, a full chassis setup should be performed. It is recommended that this setup be done at an experienced race shop with proper equipment. A basic outline of the procedure for a full chassis setup is detailed here.

Tools required:

- Level drive-on vehicle lift or scale platform
- Wrenches and torque wrench
- Sockets/socket wrench
- SmartStrings or equivalent toe alignment system
- Camber gauge
- Corner weighting scales

Setup Guide

ATTENTION!

It is necessary to properly set up your FP-DHR chassis prior to any performance driving. Failure to do so may result in loss of control of your vehicle, potentially causing serious damage as well as injury or death.

It is highly recommended that a full baseline chassis setup is performed before running your FP-DHR. Additionally, there are many adjustments that can be made to the chassis to optimize performance under varying track conditions.

The table below contains the baseline settings and will perform well in most situations. It is recommended to adjust parameters one at a time to isolate individual parameters.

Adjustment	Minimum	As delivered	Maximum
Front Rebound	0	5	11
Front Compression	0	5	11
Rear Rebound	0	3	11
Rear Compression	0	3	11



FORD PERFORMANCE

2024 Mustang Dark Horse R

Front Tire Pressure**	N/A	30 psi cold**	N/A
Rear Tire Pressure**	N/A	30 psi cold**	N/A
Front Camber	-1.5 deg	-3.5 deg	-4.25 deg
Rear Camber	-.25 deg	-1.75 deg	-2.00 deg
Front Caster	7 deg	7.5 deg	8 deg
Front Toe	Toe out recommended	.12 deg out	<.35 deg out recommended
Rear Toe	Toe in recommended	.25 deg in	< .4 deg in recommended
Front Anti-Roll Bar	Single position	Single position	Single position
Rear Anti-Roll Bar	Single position	Single position	Single position

**Your FP-DHR is shipped with Pirelli P-Zero street tires at 30 psi of pressure. These tires are recommended ONLY as transportation, storage, and setup tires.

For all measurements, care should be taken to measure on a flat and level surface. Additionally, all suspension parameters are best taken with equalized corner weights with a driver in the car if possible.



FORD PERFORMANCE

2024 Mustang Dark Horse R

12.0 KEY CONTACTS

Ford Performance

777 Republic Drive

Allen Park, Michigan 48101

United States

Dave Born

313-805-8868

Ford Performance Racing School

6026 Victory Lane

Concord, NC 28027

United States

Glenn Long

919-614-4797

Michelin

Technical Assistance

Casey Halbrook – casey.halbrook@michelin.com

Sales

Evan Wright - Evan.Wright@jacksonmg.com

Watson Engineering, Inc.

18703 Dix-Toledo Hwy

Brownstown Twp. MI 48193

United States

Pete Fortner

734-759-0555



FORD PERFORMANCE

2024 Mustang Dark Horse R

Multimatic Special Vehicle Operations Group

1100 Stackhouse Road

Newmarket, ON

Canada

L3Y 8X6

J-F Chretien

214-213-9878

Capaldi Development Inc.

28233 Kehrig Drive

Chesterfield, MI 48047

United States

Leo Capaldi

586-949-7223

Carl Hass

500 Tower Parkway

Lincolnshire, IL 60069

United States

Ryan Howell

847-634-8200



FORD PERFORMANCE

2024 Mustang Dark Horse R

Brembo Racing / Race Technologies

7275 West Winds Blvd.

Concord, NC 28027

United States

Technical

Brandon Miller

714-204-8044

Orders

Danni Jacobs

714-438-1153

Connor Noble

714-438-1153 ext. 218

Recaro Automotive North America, Inc.

24801 Capitol Blvd,

Clinton Twp. MI 48036

United States

Sean Kolb

248-874-5482

Sparco Motor Sports, Inc.

1852 Kaiser Avenue

Irvine, CA 92614

United States

949-797-1750

Motec USA

235 Raceway Drive

Mooresville, NC 28117

United States

David Gibson

704-799-3800



2024 Mustang Dark Horse R

Cortex

1280 State Route 28
Loveland, OH 45140
United States
Rick Reynolds
415-489-0866

Robert Bosch LLC

38000 Hills Tech Drive
Farmington Hills, MI 48331
United States
www.bosch-motorsport.com

Precision Race Services, Inc (PRS)

16749 Dixie Highway
Suite 9
Davisburg, MI 48350
David Decker
248-634-4010

HRP

9804 W Primrose Ln
Edwards, IL 61528
United States
Mike Dreith
309-691-8789



FORD PERFORMANCE

2024 Mustang Dark Horse R

Brown & Miller Racing Solutions (BMRS)

1 Carpenter Ct. NW

Suite 400

Concord, NC 28027

Unites States

Andrew DeBarge

704-793-4319

Borla

500 Borla Drive

Johnson City, TN 37604

United States

Debra Lewis

423-979-4015